

Issue # 10

US \$4.95

BattleTechnology

The Magazine of Combat in the 31st Century

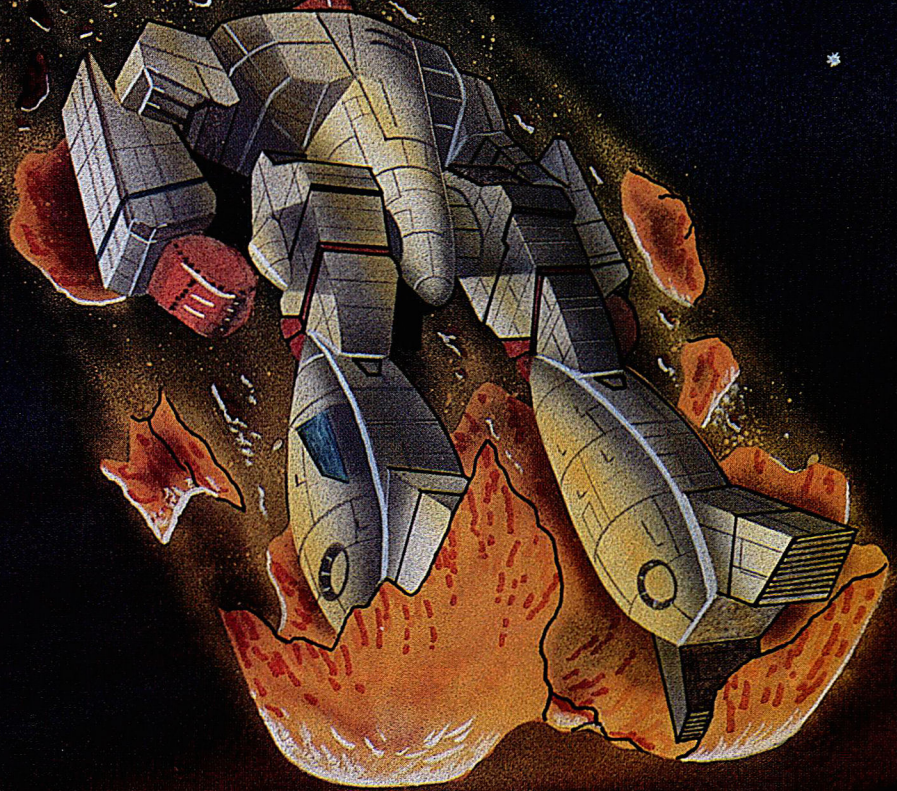

Janos Marik Slain

THEY ARE COMING.

NOTHING WE HAVE CAN STOP THEM.

MICHAEL A. STACKPOLE

LETHAL HERITAGE

BLOOD OF KERENSKY • VOLUME ONE



A BATTLETECH NOVEL

From beyond the Periphery

comes a threat. A threat

whose power, speed, and

ferocity are unparalleled. A

juggernaut whose sole

reason for being is battle.

THE CLANS.

Humanity's only hope is for Davion and Kurita to stand side by side.

Lethal Heritage is the first of a new trilogy by Michael A. Stackpole, author of the *Warrior Series*. Look for *Lethal Heritage* in July where you buy games.

BATTLETECH is a Registered Trademark of FASA Corporation. Lethal Heritage is a trademark of FASA Corporation. Copyright © 1989 FASA Corporation. All rights reserved. FASA Corporation, P.O. Box 6930, Chicago, IL 60680.

FASA products are exclusively distributed by JM Games • Chart House • Station Road • East Preston • Littlehampton • West Sussex • BN16 3AG • England, and by JEDKO Games • 134 Cochranes Road • Moorabbin, Victoria • Australia 3189.

BattleTechnology

The Magazine of Combat in the 31st Century

Issue # 10
December 3035

Publisher: Jeffrey Tibbetts
Assistant to the Publisher: Hilary Ayer

Editor: Hilary Ayer
Founding Editor: William H Keith Jr
Founding Art Director: Nina Barton
Limited Consultant: Robert Tibbetts

Editorial Offices:
BattleTechnology
3833 Lake Shore Avenue
Oakland, CA 94610

BattleTech, CityTech, AeroTech, Mech, MechWarrior, BattleTroops and *BattleForce* are registered trademarks of FASA Corporation, Chicago, Illinois, and are used with permission.

PACIFIC RIM PUBLISHING COMPANY
3833 Lake Shore Avenue
Oakland, CA 94610

Kenneth Gaydish Chairman
Jeffrey Tibbetts President

BattleTechnology The Magazine of Combat in the 31st Century [ISSN 0895-030X] is published bimonthly by Pacific Rim Publishing Company, 3833 Lake Shore Avenue., Oakland, California 94610. Subscription rates are \$24.00 for six issues in the USA, APOs, and FPOs; \$30.00 for six issues in Canada; \$48.00 for six issues elsewhere via air mail. All payments must be made in US funds drawn on accounts in the USA or postal money orders. Changes of address must be sent to our post office box and must allow six weeks for the changes to take effect. POSTMASTER: Send address changes to BattleTechnology, P.O. Box 23651, Oakland, CA 94623. BattleTechnology is a publication of Pacific Rim Publishing Company. Printed in the USA. Copyright 1988 Pacific Rim Publishing Company. All rights reserved.

Cover: Gary A Kalin
Photography: Nelson Snook and Michael Haggerty
Art in this issue:

Wildcat Blueprint & art on p 39, 40
by Gary A Kalin

Munin LAM, Cerberus
by Eric Gaydish
art pp32-38 and 45-49
by Mac Art Productions
Bar Scene p 18

by Linda Lee Pivachek
Marauder Heart and Maps
by Hilary Ayer

All other Art by William H Keith Jr

Writing in this issue:

Not Always a Great Notion
by Glen L Mitchell
Away Boarders

by Thomas A Gressman
Slaughterhouse 3005
by John A Theissen
Assassin!

by Gregory J Smith
Cerberus Aerospace Fighter
by LL Ward

Wildcat Tanker
by Gary A Kalin

Rift Into Hel, Memory's Surprises, Who Killed Janos Marik,ads, Worldbook: Rasalhague and Rasalhague, a Glance at Independence
by Stefan Paul Melin-Dempsey

Tor Miraborg Interview, Rasalhague Training Unit Interview
by Hilary Ayer and Stefan Paul Melin-Dempsey
All other writing this issue by Hilary Ayer

About the Cover:

A 'Mech drop, ablative coating burning off as the 'Mech falls through the atmosphere of Alcyone.

Artist, Gary A Kalin

Contents

Who Killed Janos Marik?	10
Anonymous	
BattleTechnology Interviews:	
Tor Miraborg, Rasalhague's Iron Jarl.....	14
Not Always a Great Notion	
Tales of the Cobalt Coil #2	18
Comrades At Arms	23
Menig Daniel Horgunse	
Rasalhague, A Glance at Independence	39
Johann Sorenson	

DEPARTMENTS

BattleTechnology News Service	4
Worldbook: Rasalhague	7
Gossip Reprint: You Can't Win	
Kumala Chatterjee	8
MechTac	
Away, Boarders!	32
by Harrison Coulter	
BattleMechanics—	
Technical Readout	
AT-1B Wildcat Class Aerospace Tanker	28
BattleTechnology Blueprint # 3	
AT-1B Wildcat	30
Technical Readout	
Munin LAM	54
Technical Readout	
Cerberus Aerospace Fighter	58
Reader's Page	60

BATTLETECH SIMULATOR

Scenarios:

Rift Into Hel	50
Memory's Surprises	52
Slaughterhouse 3005 NAIS Training Simulator	56

Assassin! —

A Scenario for Mechwarrior

45

Distribution:

American & Canada: Your favorite Game or Comic Distributor

Australia:

Jedko Games, 134 Cochranes Rd, Morabbin, Victoria 3189

UK & Europe:

TM Games, Chart House, Station Rd, East Preston, Littlehampton West Sussex BN 16 3AG, England

OPENING SHOTS

A New War?

'Where were you when the Fourth Succession War began?' brought us a fascinating series of letters. We have been publishing them for a decade now, and there is no end in sight. From time to time on significant anniversaries we may still publish them, but it's time to move on to other topics, folks.

With the interest sparked by that write-in, we got a gratifying amount of material by writers and artists unknown to the magazine. This is one magazine where the editor reads everything personally, so...it's going to take a while to get through it all. The things that don't work at all for us will be returned as soon as they're read. The things that almost work will take a little longer to get back. Please be patient.

Now, for the rest of you. We're doing another write-in page from our readers. This one calls for judgement. How good an analyst are you? **What will happen if House Davion and House Kurita fight a war?** Would they each be fighting alone this time? Would House Steiner fight a basically Davion war? Would the moody Romano Liao aid Takashi Kurita? Would The Marik? Where would Rasalhague line up? Andurien? Let's imagine there's a war, say, five years from now, in 3040. What is your prediction? We here at BattleTechnology will hold on to your answers until that time to see how close you come to the truth. Then we'll print them, as many as we can.

Bob Carter is off on one of his fact-finding trips. This one is a rumor we all hope proves true, the rumor that William H Keith, Jr, Nina Barton, and our comrades we thought dead in 3028, had actually faked their own deaths in order to evade detection. They proceeded to a supersecret lab where they...but we don't have all the facts in yet; how can I tell you? More exciting news in our next issue, but meanwhile, for your enjoyment and information, we present...

For this issue, we have traveled to Ginzburg, the capital of the province of Radstadt in the newly independent Free Republic of Rasalhague. From here we unveil the highly controversial series of articles on the death of Janos Marik, with its veiled accusation in the last article in the series, reprinted for a wider circulation, an interview with Rasalhague's ranking military mind, a short history of Rasalhague by a historian from one of the region's oldest families, a battle account by Menig (private) Daniel Horgunse, rules for combat in the freefall corridors of a JumpShip, a MechWarrior scenario set in the Magistracy of Canopus, and a new Cobalt Coil story.

Hilary Ayer, Radstadt Province, Free Republic of Rasalhague December 27, 3035

NOW IT CAN BE TOLD!! Leutnants Scott A Kreiser and Robert A Gross Jr are not missing, as was erroneously supposed. These two MechWarrior-Techs, co-inventors of the versatile Lynx BattleMech (See BattleTechnology, March 3030 issue) have been active in the service of House Steiner, working on a new sophisticated targeting/tracking system for their formidable 'Mech. BattleTechnology apologizes if our attempts to reach you at the end of the Fourth Succession War caused security problems. Thank you for the 'Mech design!

**BattleTechnology
Office hit by
Earthquake!!**

As we go to press, our Terran office in California has just been hit by an earthquake. All BattleTechnology personnel are well. Due to shipping problems (collapsed highways and bridges), publication of this issue will be delayed by about a week. It reminds us that no matter what our level of technology, even in the Star League era itself, nature can force our plans to change.

Our offices and ourselves are fine. Our support services are returning to normal. We will soon be back on schedule.

Thank you for your support and your patience.

BattleTechnology

The Magazine of Combat in the 31st Century
The **only** authoritative news magazine covering the Inner Sphere.

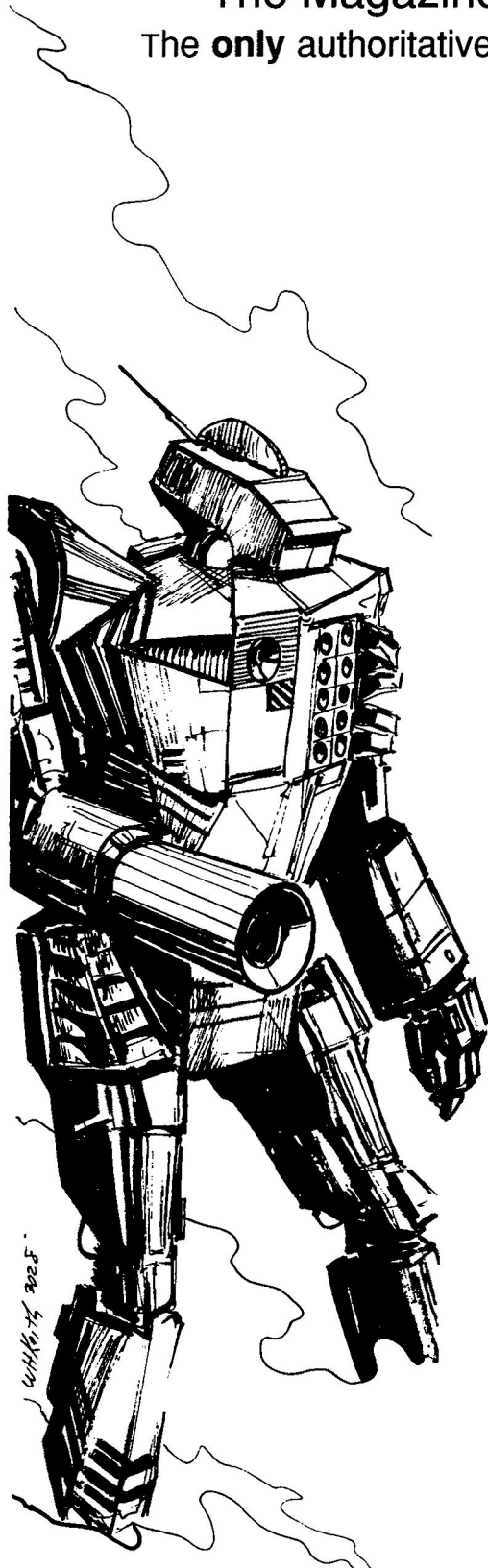

BattleTechnology . . . Because the only good merc is a live merc — dead ones can't shop at my store!

— Abraxis (Mo) Murasaki, Owner
Battletechnic Military Salvage

BattleTechnology, with its BattleTech Simulator, is the best Mech Warrior training device I know — relaxes you after combat, and sharpens your skills at the same time. Don't leave home without it — unless you want to die young!

— Captain Mamluke 'ap Prentiss,
Drillmaster,
The Faoes' Own Independent Lowlanders

Even **BattleTechnology**, which tries to remain unbiased, has printed colorful lies about the Capellan Confederation...

—T'eng Lu,
Maskirova Official

BattleTechnology is available from finer merchants throughout the Inner Sphere, from our publishing house on New Avalon, or from:

BattleTechnology
Post Office Box 23651
Oakland, California 94623

Subscriptions are available at \$24 US in the US, \$27 US in Canada, \$48 US elsewhere on Terra.

Back issues 0101 through #7 still available postpaid at \$3.95 in US, \$4.95 US in Canada, \$5.95 elsewhere on Terra. Issues # 8 and after are \$1 more.

0101, August 3027 — report on Davion Op Galahad, MechWarrior mental discipline, FLC-4N 'Falcon' Mech, Battle of Kilgore Engine Swaps, Combat drop on Scheat V, more.

0102, December 3027 — Combat Salvage, Camouflage, Hassid Ricol: The Red Duke, Black Luthien: the Draconis capital, DVE-5B 'Devastor'

0201, February 3028 — Tharkad, Decompression, GLD-3R 'Gladiator', BattleMech Weapons — range versus accuracy, Galaina the Pleasure Planet, Vacuum combat, more.

0202, April 3028 — Hanse Davion Interview, Cavalry Tactics & Applications, Lasers, Banshee BattleMech, Dragonslayers, Battle at Wittengate

0203, June 3028 — Maximilian Liao Interview, Kearny Highlanders on Mira, Liao Edge on Solaris, Urban Camouflage, more

0204, August, 3028 — WAR BEGINS, Goliaths on St Andre, Miniatures Combat, Reports From the Front, Close Assault

#7, March 3029 — ALI-1A Alliance, BattleMech Technician, The Phransigar, New Invasions

#8, September 3029 — FLE-14, Athena, Davion Cut off by ComStar, Cobalt Coil, Blood on the Snow

#9, March 3030 — WAR ENDS, VTOLs, Beatie Hovertank Blueprint, Skyfall, Assault on Kusari, Marik Diary

BattleTechnology News Service



Andurien
Aerospace
fighter
awaits
Free Worlds
reprisals

Andurien Revolt Causes Marik Stroke

Atreus, December 15, 3030

A month ago today, Janos Marik was winning at last. Readers will remember that when the Fourth Succession War ended, the Captain-General faced a challenge to his authority and his office from Derek Cameron-Jones, Spokesman for the Principality of Regulus. After Andurien declared its independence in May, The Marik's prestige was at an all-time low. While doomsayers were predicting the loss of office for the head of House Marik, Janos Marik was drafting the comprehensive Internal Emergency Act. For the duration of the Emergency (which one is not specified in the act, although it was drafted against Andurien), most of the member states have agreed to give up their sovereign powers. Andurien and Canopus are allied; a marriage between Richard Humphries and Emma Centrella is predicted. The only exceptions to the Emergency Act are the Principality of Regulus and the Duchy of Oriente. Regulus, analysts conjecture, because it might easily join the rebels if pressed. Oriente, because of the known, proved loyalty of Duke Christopher Halas.

Captain-General Marik emerged from that struggle stronger than ever. But struggle it was — and Janos Marik is not a young man. Two nights ago he suffered a near-fatal stroke. He is now in intensive care at Cedars-Marik Hospital in the capitol.

Street fighting has followed the attempt of Duggan Marik to declare himself regent for his father. His chief challenger is his cousin Duncan Marik. The planetary governor, TadiczSikorsiki, has called upon the local militia to restore order.

Skye Crisis Defused!

Skye, May 21, 3034

Duke Ryan Steiner today announced the results of his counseling in what has come to be called the Skye Crisis. Inspired by Rasalhague's declaration of independence, many of the less-disciplined separatist groups in the Isle of Skye attempted an uncoordinated coup, occupying public buildings, looting and rioting, calling strikes, etc.

Two weeks ago agitators and students from nearby Flora MacDonald University occupied the Royal Edinburgh Steelworks. Loyal troops from the Federated Commonwealth regiment nearest at hand were called in to restore order. Unfortunately they were elements of a Davion regiment. Once they had taken position, they could not withdraw. Propagandists made much of innocent youth menaced by the foreigners.

Things could have been bloody. Three days ago, Duke Ryan's personal DropShip landed on Skye. The Duke offered to mediate between the two parties; for three days he has hardly slept as he worked for a peaceful solution.

The students have left the building; amnesty has been declared. Duke Ryan has expressed his sorrow that elements loyal to him might have so misunderstood his words as to consider it his wish that they riot and cause civil disorder. Once again the Duke avows that there is no connection between the 'Hanse-off' movement and himself, "though as an expression of popular sentiment I cannot entirely condemn it."

Duke Ryan, whatever his private beliefs may be, has achieved the grateful thanks of the people of the Isle of Skye.

Continued

BattleTechnology News Service

Skye citizens are rebuilding from the damage of the Fourth Succession War; they want calm more than they wantt independence. At least, as of now they do...

Janos Marik Recovers!

Atreus, January 24, 3034

Today is the fourth anniversary of the day Thomas Marik stood before the Parliament of the Free Worlds League to produce documents proving him to be Janos Marik's chosen heir to the Captain-Generalcy. He had been on Terra, securing his release from his vows to ComStar when the news of his father's stroke arrived. He was declared regent at once.

In his four years of regency, Thomas has been perceived as intelligent, fair, and aware of regional problems. It had been speculated that the real ruler of House Marik would be ComStar; Thomas has walked a careful line, being neither partial to them nor prejudiced in the other direction.

Today he stood before Parliament producing documents again. These were certificates proving his father's recovery from his illness and readiness to resume his full duties as Captain-General.

Interviewed afterwards, Thomas Marik wore an uncharacteristic broad smile. "Let the Old Man tend the family business for a while. I have a date with some fish." Reliable sources say that Thomas will not idle for long; there's too much work for the Heir-Designate.

Skandia, May 3035: Ronin Warhammer faces off against Rasalhague Phoenix Hawk during relief of Jotunheim

Kurita Old-Line Military Revolts!

Rasalhague, April 3, 3034

Three weeks ago Prince Haakon Magnusson proclaimed the independence of the new Free Republic of Rasalhague. Even as spokesmen for House Kurita gave press statements welcoming the new nation, conservative die-hards within the Draconis Combine prepared a very different response. Warlord Ivan Sorenson, who might have been a voice for moderation, was assassinated before he could declare himself. Marcus Kurita is quoted as saying "If the Old Tree cannot stand the Winds of Storm, and the Young Tree is eager to bow to them, those few who know Honor must send the wind back whence it comes". Marcus has seen an opportunity and acted; he is a major leader in the attacking forces.

Kanrei Theodore Kurita expressed the official opinion of his House when he dubbed these rebels *Ronin* or masterless. He has refrained from other comment out of respect for Marcus' daughter, Keeper of the House Honor Constance Kurita. Sources close to him say he is prepared a force to aid *Rasalhague* against rebel Kurita forces.

Fighting is fierce on Vipaava, Last Frontier, Jezersko and Trondheim. Radstadt has repelled its first invasion force, while Kempten seems likely to fall. DropShips are en route to Skandia, Maule, Utrecht, Altenmarkt and Dehgolan. Look for the fighting to continue for some time; each force has a deep commitment in this conflict.

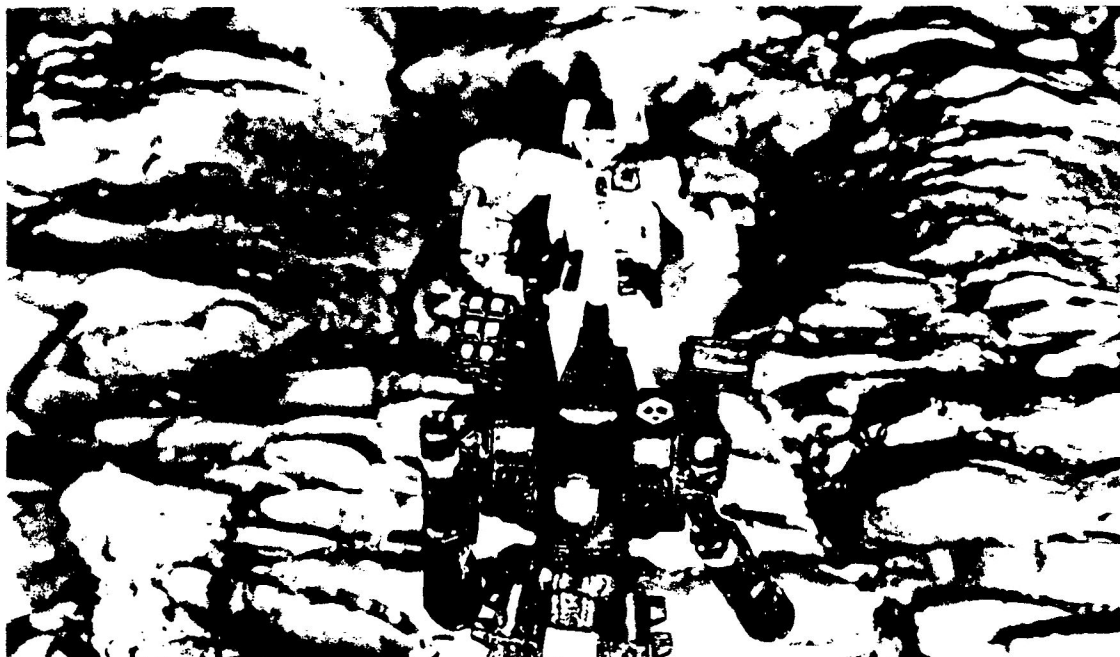

BattleTechnology News Service



Archer on right is that of Kadett-Lojtnent Sven Lorensen

A Very Mixed Unit

The mixed units of the Ronin Wars have caused some strange combinations. By treaty with the Combine and the Commonwealth, officers from both houses were to train regular forces for the Kungsarmee of the Free Rasalhague Republic. Nobody expected these forces to be at war quite so soon, but the Ronin Rebels struck, suddenly and viciously. The units that responded were led by a Steiner or Kurita officer and composed of Rasalhague citizens who months before had been fighting Steiner and/or Kurita troops. In a few cases, we have an army unit composed of all three forces. How do such units manage to accomplish their objectives despite differences in training and philosophy?

Today we interview three mechwarriors who have fought side by side although they had been raised to dislike and distrust one another. Let me introduce them in order, from senior to junior,

I am interviewing Captain Takashi Hiro, Leader of the Recon Lance, who owes allegiance to the Draconis Combine. Captain Elizabeth Rychek (whose date of commission is one year to the day after Captain Hiro's), leads the Fire Lance; she is a product of the Lyran Commonwealth. Lojtnant-Kadett Sven Lorensen served as an irregular with the Tyr; at 28, he is now the senior cadet-member of the Kungsarme Second Regiment, Training Company Alpha.

BT: Captain Hiro, how did you come to get this command?

Hiro: Coordinator Takashi Kurita through his son Kanrei Theodore Kurita asked several of the regular units for volunteers who would assist our honorable new neighbors in becoming a potent fighting force. I thought it was a good idea, so I volunteered. I haven't had a finer bunch of students since my days as a training instructor at Sun Xiang Academy eight years ago.

BT: Captain Rychek, how did you get here?

Rychek: I came in contact with Rasalhague troops a bit earlier than Capt Hiro. I was one of the officers who trained the Tyr regiments before the Fourth Succession War. I'd like to put it on record that I agree with Capt Hiro on at least one matter — the caliber of the troops here.

BT: Kadett-Lojtnent Lorensen, how does it feel to be back in basic training again?

Lorensen: I never thought I'd be back. I can live with it. It's difficult, but it's important for us to know how both the Draconis Combine and the Lyran Commonwealth teach their mechwarriors and their other units how to fight, so we can profit from both of their greater experiences.

BT: Aren't the two Houses opposite to each other in tactics and battle doctrine?

Lorensen: Yes, they are different, but each side has ways in which they are superior. An example being (he looks at Hiro, then at Rychek) the *bushido* code of the Draconians as a base, added to the Germanic tenacity of the Lyrans. I feel that the Kungsarme will be able to function better as a whole taking example from both forces.

BT: Capt Hiro, what for you is the strangest thing about working with Lyrans?

Hiro: (Slowly) To actually find one who doesn't believe in all the pomp and circumstance that Lyrans seem to relish, and one who actually has a mind for tactics and for battle strategy.

BT: Capt Rychek, same question about Kuritans?

Rychek: (Hides a grin) It supprises me that Capt Hiro requests and acts on feedback from the troops. It's quite against the stereotype for Draconians. I don't mean that a battlefield should be a democracy, but the fighters, to give their best,

Continued on page 50



Worldbook

Rasalhague

Center of Government
Free Republic of Rasalhgue

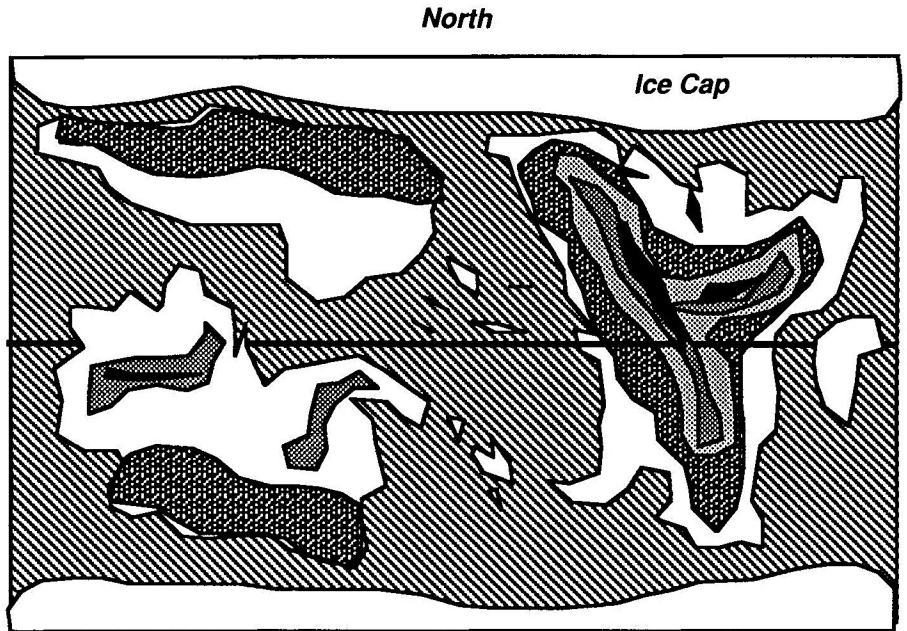
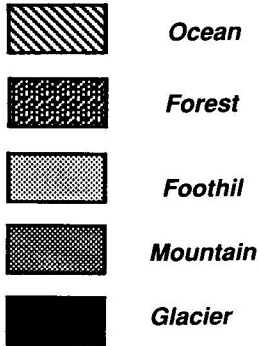

Star: Rasalhague
Type:K4V
Mass: .89 Sol
Lumiosity: .43 Sol
Radius: .87 Sol

System Data:
Planetary system 9 major bodies,
3 asteriod belts

Planetary Data:
Planet: NSC C 4-751-684-2; Rasalhague VI
Comon Name: Rasalhague
Mean Orbital Radius: .85 AV
Orbital Eccentricity: .010
Period: 436 days, 13 hours, 12.31 seconds
Mass: 1.021 Earth
Equatorial Diameter: 10682.44 km
Radius: 5341.22 km
Mean Surface Gravity: 1.010 G
Escape Velocity: 11.42 kps
Rotational Period: 36 hours, 32 minutes,
12 seconds
Axial Inclination: 1 degree, 18 minutes,
2 seconds
Atmosphere: 110 degrees C
(equator, midafternoon)
to -70 degrees C (midnight)
Time to Jump Point: 4 days
Recharging Stations: Zenith, Nadir

People:
Population: 4,967,000,000
Ethnic Groups: Scandinavian 83%, Oriental 15%, Other 2%
Languages: Swedish 70%, Japanese 28%, Other 2%
Religions: Protestant 45%, Buddhist 25%, Church of Blake 10%,
Universal Catholic Church 10%, Muslim 05%, Other 05%

Government:
Allegiance: Free Republic of Rasalhague
Government: Representative Democracy
Head of Government: Prince Haakon Magnusson

Economy:
Natural Resources:
Agricultural: Wheat, Oat, Barley, Corn, Misc Vegetables
Ores: Cola, Gold, Platium, Uranium, Copper, Iron
Processed Goods: Electronics, Vehicles, Entertainment
Labor Factors: Agricultural 30%, Mining 21%, Processed Goods
20% Service 15%, Administration 12% (Rasalhague is the Center of
Government for the Free Republic of Rasalhague)

You Can't Win

Kumala Chatterjee from her bestseller
To Inform the Dragon, Panjandrum Press, Genoa, 3035

In my contract it says that I am to cover marriages, births, affairs de coeur, scandals, etc. I am forbidden to mention politics. But what's a girl to do when births and marriages are but totally tangled with politics? Since the start of this decade, we've seen:

— 3030 Victor Ian Steiner Davion, the first of the children (3 to date) of First Prince Hanse Davion of the Federated Suns and Archon-Designate Melissa Steiner Davion of the Lyrans Commonwealth; with this birth the Alliance becomes fact. I can look at the press pictures of a rosy baby, then at a bright-eyed, happy child. But how can I limit myself to discussing his walkies with nurse when what my readers want to know is *Where is he going to be raised?* In Tharkad, at the court of his grandmother, Archon Katrina Steiner. *Where will he live when he succeeds to both thrones?* He will alternate years in the Lyrans Commonwealth with years in the Federated Suns. His sister Kate (now 3) will be regent for the Federated Suns while he is in the Lyrans Commonwealth; his brother Peter will do the same for the Lyrans while the Archon Prince (as he will be titled) is in Davion mode. *When will all of this happen?* Not until both of his parents abdicate in his favor...or, of course, die.

— 3033 The long-hidden marriage of *Kanrei* Theodore Kurita, Prince of Luthien, to Tomoe Sakade, mechwarrior with his Legion of Vega (and near-commoner) is revealed. Their oldest son Hohiro is an able young man in his early teens who goes everywhere he can with his father now that he need not be hidden. Hohiro, together with his brother Minoru, and his sister Omi is the major reason why Coordinator Takashi Kurita is reconciled to the marriage he had no part in making. Indeed, during the twelve years that the *Kanrei's* marriage was a secret, he was continually exerting himself to escape his father's marriage plans for him!

— 3033 Birth to Morgan and Salome Kell of a son, Phelan, is celebrated. The CO and XO of the Kell Hounds announced the expectation of a child during a visit to Col Jaime Wolf on the Wolf's Dragoons world of Outreach for state-of-the-art medical counseling on infertility. Phelan is yet one more healthy example of Inner Sphere babyhood. Another new Kell Hound is clearly in the wings. Salome has reluctantly agreed to stay out of her 'Mech for the last trimester before birth. She resents the necessity but can't

quarrel with the reasoning.

— 3034 President Neil Avallar of the Outworlds Alliance has welcomed the military presence of ComStar on his worlds. Two new HPG stations have been built, with more in the planning stages. Diplomatic and educational teams spread the Word of Blake throughout the Alliance, while three new Guard units give aid against the perpetual bandits.

President Avallar has sought alliance with other Periphery kingdoms. Distance from the Magistracy of Canopus makes a practical alliance difficult, while the increasing tension between the Magestrix and her heir makes it difficult to know which side to ally with. The increasing paranoia of Thomas Calderon makes an alliance with the Taurian Concordat impossible to achieve. If President Avallar wishes an ally, he must look to the Inner Sphere.

In 3034 he married Baroness Rebecca de Sanders, Chargee d' Affairs in the AFFS Embassy to the Outworlds Alliance. She has not technically resigned her position, but is on indefinite leave. In September of this year, their son Mitchell Avallar was born. ComStar is not reported to have led the general rejoicing.

To give a more lengthy example of how difficult it is to disentangle affairs of the heart from affairs of state in this Marrying Decade of the 3030's, let's look at two marriages from the first half of the decade:

The first is that of Justin Xiang Allard to Candace Liao, Duchess of St Ives. Candace is the daughter of Chancellor Maximilian Liao of the Capellan Confederation; until her flight with Justin she was heiress to House Liao. Justin is the reknowned mechwarrior, son of Minister of Information Quintus Allard of the Federated Suns. In an elaborate campaign of deception, Justin was tried and exiled by Prince Hanse Davion, built up a record as a Federat-hating 'Mech Pilot-Gladiator on Solaris, became co-head of a Capellan task force linking the Armed Forces and the Maskirova or secret service, and convinced Chancellor Liao to retool most of his best fighting 'Mechs with a useless "Triple Strength" myomer muscle fiber which disintegrated under combat conditions. When Duke Morgan Hasek-Davion's forces rescued him, Justin brought along another passenger, Duchess Candace. (By the way, Duke Morgan's Duchess, the former Kym Sorenson, who was once a sweetie of Justin's in his Solaris days, has announced her state of Happy Expectation. Do you begin to see why I feel the Inner Sphere is awash in Very

Important Babies?), The St Ives Compact is now a small independent state between Houses Liao and Davion, with strong political ties to Davion and emotional ties to both, ruled by the Duchess, with an independent legislature to advise her. Justin runs security for St Ives and aids the Duchess' brother Tormana Liao in his efforts to return stable government to House Liao.

Take a deep breath, gentle reader! *Now* it starts to get complicated! Whether or not Acting Chancellor Romano Liao had wanted Justin for herself, or simply had wanted Candace's status as heir, it is unequivocally clear that Romano hates Candace with a rage that is strongly flavored with jealousy. Phransigar assassination teams have twice made attempts on the lives of Candace and Justin. The second and more serious attempt was made in 3031 when Candace announced her pregnancy. Romano promptly became pregnant herself without the formality of marriage. These events resulted in the births of Kai Allard-Liao late in 3031 and Sun-Tzu Liao in 3032. Kai is a family name; Sun Tzu is the famed military strategist of the old Chinese state on Terra. The babies continue to flourish; the assassins do not.

Contrast this with 3034's Marriage of the Year, that of Ryan Steiner, Duke of Porrima, Ruler of the Isle of Skye, with Morasha, daughter of Duke Selwin Kelswa of the Tamar Pact.

The bride was beautiful — and almost totally ignored. The toasts at the wedding feast were, in order, to the bride's father, the groom, the heads of each of their armed forces, the grandchildren yet to become, and — oh, yes, a happy marriage to whats-her-name.

So far Duchess Morasha has none of the fire of her father. She appears on her husband's arm on state occasions; her smaller chair is placed next to his in the Reception Chamber, but it is rarely occupied.

The cruelest comment on their marriage was overheard; two members of Rasalhague's delegation to the wedding, forgetting that Swedish is spoken in worlds other than their own systems, were heard offering two to one odds that the first offspring of the marriage would be, not a child, but a company of BattleMechs...

Keep politics out of love, O Honorable Editor? Not in the real universe. As well try to keep love out of politics.

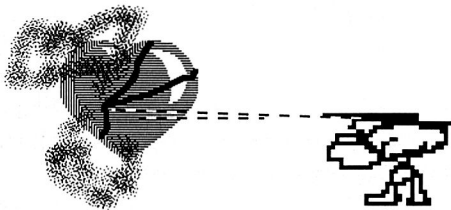

The following ad page from *MechWarrior of Fortune's* August 3035 issue may serve to explain why the article series on the next few pages is anonymous:

Want Ads / Bounties

Wanted: A group of mechwarrriors who are interested in making some good, legal, money for a high risk job of a vital nature. If you are willing, contact Box 3025 on Tamar in the Tamar Pact. Compensation guaranteed to next of kin.

Wanted: Information regarding the whereabouts of one Sho-I Miko Mikaru, Third Sword of Light. Last seen on Rasalhague. Reward: 5,000 C-bills. Contact Box 01095, Luthien

Wanted: Information leading to the capture of Mikial Dragnos, former Free Worlds League citizen. For useful information, 1,000 to 4,00 M-bills. For capture, when brought to a Free Worlds League Embassy, or any Free Worlds League planet: 25,000 M-bills dead, 100,000 M-bills alive.

For Sale: Striker scout vehicle in good condition. Has only 2,000 km on it since last rebuild. Has several battle scars — for decorative purposes. Highest bid accepted. Contact Box 981, Exeter

Wanted: Trainee gladiators willing to risk their precious necks for big money! Excellent pay, room and board. Not for the squeamish. Contact Box 5098, Solaris

In The News...

Who Killed Janos Marik?

One of the most terrible acts to happen in the year 3035 was the assassination of Captain-General Janos Marik. How this action has affected the future cannot yet be assessed. The murder of the Marik has caused some of the greatest controversy in the history of the Inner Sphere. The primary cause for this controversy: not a single group has come out and formally stated that it killed The Marik and his sons Thomas and Duggan. The bombing triggered a series of editorials which were published in the *Atreus Herald*. It is now believed that they are the work of scholar-in-hiding Mikial Dragnos, former award-winning citizen of the Free Worlds League; readers of *BattleTechnology* will remember a number of articles by Mr Dragnos on historic assassinations.

Who Killed Janos Marik?

One of the most terrible acts to happen in the year 3035 was the assassination of Captain-General Janos Marik. How this action has affected the future cannot yet be assessed. The murder of the Marik has caused some of the greatest controversy in the history of the Inner Sphere. The primary cause for this controversy: not a single group has come out and formally stated that it killed The Marik and his sons Thomas and Duggan. The bombing triggered a series of editorials which were published in the *Atreus Herald*. It is now believed that they are the work of scholar-in-hiding Mikial Dragnos, former award-winning citizen of the Free Worlds League; readers of *BattleTechnology* will remember a number of articles by Mr Dragnos on historic assassinations.

Janos Marik Assassinated

An unknown assassin or terrorist group has set off a bomb, killing the Captain-General, his heir Thomas Marik, and several others. On June 1, 3035, Janos Marik called a meeting of his family and several representatives of the Diplomatic Corps. The primary goal of the meeting was to decide how to bring Andurien back into the Free Worlds League. It is also believed that the Captain-General was planning to announce his retirement, and to hand over the reigns of power to Thomas, his youngest son who had been in command since 3031 because of the stroke Janos suffered in May of that year.

The meeting was destined never to finish. It is assumed

that The Marik wanted to teach Andurien and any others who might have been considering revolution a stern lesson. Each potential plan was refused on the ground of infeasibility, lack of understanding of the nature of the problem, or simple ludicrousness. Hours came and went and certainly tempers became foul; at 6:00 pm, the Captain-General called a recess of two hours. Sometime during that break the bomb must have been planted; later it was determined that it had been concealed in a portable holotube.

During the next two hours, everything was proceeding smoothly with the plans to bring Andurien back into the fold. Then Duncan Marik, commander of the Marik Militia, and nephew to The Marik, received a private message and excused himself to take a call. Fifteen minutes later the bomb exploded; apparently all who were in the room were killed. This included Janos Marik, Thomas Marik, the older son Duggan Marik, and several member of the Diplomatic Corps. One of the first people on the scene was Duncan; he had started removing victims while the fire still raged. Thomas Marik must have been close to the center of the blast; his body, and those of his friend Li Mann and palace guard Alexander Haleck, were completely obliterated by the initial blast.

For the second time since the creation of the Free Worlds League, the Marik family has almost been destroyed. Duncan is left, of those Mariks who have shown ambition for leadership. He proved himself a hero that night, working tirelessly until all the bodies had been found. But what of Andurien? Who could have placed that explosive in the room? These and many other questions must be answered before this

mystery can be solved.

You will be sent a series of editorials which will attempt to solve the puzzle of what happened on the night of June 1, 3035. Perhaps we will never know the truth. Or perhaps the clues can be found to bring to justice the assassin of Janos Marik.

Can the Scourge of Death be Back?

Who would perform a terrorist act like the killing of Janos Marik? Could it be a terrorist organization like the Star League-era Scourge of Death? Although most of the sensational newspapers are screaming about terrorists and nihilists, what are the facts which would indicate that a terrorist group committed this crime? What facts might show that terrorists did not blow up the Captain-General and his family? Let us examine both possibilities and weigh the evidence for ourselves.

The death of the Marik family would be a crowning achievement for any terrorist group wanting to make a public statement or attract publicity for its cause. The first clue pointing toward terrorists is the device used to kill all those people, an explosive device controlled by a remote radio trigger. Secondly, it was done during a vital meeting of the family at a time of crisis, a time well chosen to ensure that the government would not be able to do an immediate reprisal against the elements which sympathized with the terrorists. The matter of Duncan Marik leaving just minutes before the

Could it have been a terrorist group that planted the explosives in the conference room? My personal belief is no. Before any meeting of the household, two teams go into the conference room to check it for listening devices or dangerous items in the room. True, the bomb could have been missed in a sweep, but it is unlikely. Secondly, and more important, a group like the Scourge of Death would have made certain that Duncan and Paul, probably with their sisters who were on planet, were killed as part of the same attempt. No attempts were made on Paul or Kristin, both of whom were on Atreus at the time. (See Scourge of Death incident, *BattleTechnology #8*). Finally, terrorists do not act anonymously. The whole purpose of a terrorist group action is to make a political change and/or statement. No statement was made.

If it was not terrorists who killed Janos Marik, who did? My next editorial will take a look at another possible suspect for the heinous crime.

Could Duncan be the Assassin?

There is of course an obvious choice to be the killer, one Duncan Marik, who was a disappointed candidate as heir to Janos Marik. Let us remember that these speculations are purely theoretical, and are only written to demonstrate the danger of taking the facts at their face value. As with previous editorials we shall compare the facts which prove and which disprove whomever is being discussed as the

Terrorists do not kill anonymously!

blast can be attributed to one of two things. Either it was pure luck on his part or the terrorists instigated the call which took him from the meeting, feeling that he would be less of a threat at the head of House Marik than his brother Paul, who is head of security for the Free Worlds League.

There is only a scant amount of evidence for a terrorist plot. Let us look at the reasons it could not have been a terrorist group. The first and most critical fact is that after the bombing no group came forward to claim the credit for killing Janos Marik. Secondly, terrorists usually have a statement to be expressed by their acts. To use the Scourge of Death as an example: the group's central belief was that the Star League was a source of evil, leading the civilized universe straight to hell. The Free Worlds League for the last six years has been trouble free with the exception of the Andurien crisis; no terrorist group has expressed a legitimate reason to commit such an atrocity.

potential criminal.

Duncan Marik would have the best of reasons and/or chances to commit the assassination. First of the reasons that make him suspect is that this would be the only way he could now become the head of House Marik. Duncan never had kept quiet about his belief that Janos Marik would make him heir-designate until 3029 when it was announced that Thomas Marik was to be The Marik's heir. Secondly, it would have been simple for him to place the bomb in the conference room at any time after the room had been swept. A third reason is that between his close blood relationship and his strong hold on the military, Duncan could be certain of the Captain-Generalship after the closer members of the family were dead. True, leaving Paul Marik alive could have caused a problem here. However, Paul is not a person who is interested in ruling an entire realm as Duncan wanted to do. Finally, it is said that Duncan had a plan, 'Operation

Shepherd's Hook', to bring Andurien back into the fold; the plan's adoption was important to him.

Of course, we must look at the other side to see why Duncan Marik would not have caused the death of his family, aside from natural affection. Since Thomas Marik began fulfilling his role as the *de facto* leader of the Free Worlds League, he made sure to consult Duncan and Duggan in many of the vital decisions that were needed during Janos Marik's infirmity. So Duncan cannot have felt that his useful public life was over; he must also have seen how much he had to learn about ruling. The second important reason is that Duncan would have been the Marik most probably chosen to carry out the battle plan against Andurien. Since he had urged that House Marik oppose the secession of Andurien, and since he had advocated the plan which seemed likely to be chosen, Duncan was in the process already of getting what he most wanted. Thirdly, while Duncan was called away he was in full view of security forces at all times, and no action he performed was indicative of setting off an explosive charge. Finally, Duncan received second-degree burns over fifteen percent of his body trying to save peoples lives during the explosion and fire. These were not the actions of a killer.

When the facts are looked at, it seems that Duncan also is not the assassin. He has the best reasons, it is true, but his character and the weight of circumstantial evidence against the possibility. If he was the assassin, we will never be certain of his involvement.

Assassins from the Succession Lords?

Each of the Lords has a group of highly-trained people who are prepared to kill the enemies of his State. One wonders if maybe one of these teams of assassins were sent to kill Janos Marik and his family. We shall look into each of the Houses' teams to see why they would wish to slaughter the Mariks.

The first Marik enemy we will look at is the Lyran Commonwealth's Loki terrorist squad. Loki is a sub-branch of the Lyran Intelligence Corps, whose primary duty is to cause dissention behind enemy lines by using the weapons of terror: fire, explosives, mayhem, and murder. This team is rarely used, though it has made enough enemies that other groups have been created to fight them (including, in part, the Tyr). Why would Loki be sent to kill The Marik and his heirs? It could have been as a prelude to another version of the Fourth Succession War's surprise attack on the Capellan Confederation, eliminating both the symbol and the reality of leadership for the Free Worlds League. Or Archon Katrina may have decided on a belated revenge for the attempted assassination of her ancestor Elizabeth Steiner. Neither of these ideas work; the Lyran reaction to the assassination was one of complete surprise. More important, no attack was

made during the confusion that followed the death of the Mariks.

The next Succession House to be examined is technically an ally, the Draconis Combine. Many people believe that the ISF (Internal Security Force) of the DEST (Draconis Elite Strike Teams) are the assassins of the Draconis Combine. In actuality the ISF are merely the spies of the Dragon, and the DEST are elite commandos. Neither have the actual capabilities of keeping a team of assassins. The actual assassins of House Kurita are the O5P (Order of the Five Pillars). They are the adepts of Budojin, mystic occult warriors who have special abilities involved with the understanding of *ki* (Universal energy of Nature contained in each individual). And why would House Kurita call for the death of Janos Marik? The Captain-General acted poorly during the Fourth Succession War, especially as the alliance between Kurita, Liao, and Marik was a mutual defense treaty against the Davion-Steiner alliance. Coordinator Takashi Kurita or his son the Kanrei could have taken offense at such a poor showing by the Captain-General's forces. The O5P Budojin assassins are known for their subtlety; they would have used a less violent technique. And they would have been sure to kill Duncan Marik as well as his family.

The third group of assassins to be looked at is the Federated Suns' Department of Military Intelligence branch known as MI6 — Special Forces. Special Forces, also know as 'the Rabid Foxes', are elite saboteurs and terrorists who deal in death and destruction throughout enemy realms. These teams only act under direct orders from Prince Hanse; they will carry out anything from assassinations to bombings or even kidnappings. Now why would Prince Davion order the deaths of the Mariks at this point and time? The only two plausible explanations would be: as insurance that Andurien remain free as a buffer state, or to divert attention from some other operation that Prince Hanse had planned against one of the other two houses. Since Duncan Marik has continued the attack on Andurien, that disposes of the first reason. Since AFFS forces did not strike at any Kurita or Liao targets, that gets rids of the second idea.

Last we come to the Capellan Confederation an their infamous Death Commandos. The Commandos are qualified to use both modern and ancient weaponry. They are highly qualified for any mission from the assassination of public officials to an assault on a major military installation; they usually succeed whatever the mission may be. An excellent example of their fearsome abilities was during September 3029, when one team attacked both the geothermal stations at Kathil in the Capellan March of the Federated Suns and the NAIS on New Avalon. In the end neither attack succeeded, though each came close, but to mount two attacks of such strength at the same time testifies to their ability. The only reason that Chancellor Romano Liao would have for sending

out the Death Commandos to kill Janos Marik is because of the problems that were mentioned with House Kurita; not aiding the Liao forces with the AFFS attacks who all but halved Liao territory during the Fourth Succession War five

been set off by some sort of coded radio transmission.

Many people may consider this to be insufficient circumstantial evidence to convict the Duchy of Andurien of the crime of assassination. In order to "convict" them, let us consider motive; the great advantages they stood to gain. If

His first act was to declare war on Andurien!

years ago. Chancellor Romano does not always behave as reason would dictate, of course. But these assassin teams have been exclusively focused on Tormana and Candace Liao, and on Candace's husband Justin Xiang Allard, since the end of the war. House Liao, despite its centuries-long enmity for House Marik, seems unlikely as the killer.

The assassins of the Succession Lords are all qualified to have completed this particular assassination. All of the evidence showing that any one of the teams could have completed this deed is all conjectural, circumstantial at best. I believe that none of the other Lords ordered the killing of Janos Marik and his kin.

Andurien — Insurance for Freedom?

Under Dame Catherine, the Duchy of Andurien left the Free Worlds League in September 3030. The meeting that the Mariks were in when the bomb went off was a strategy session to decide how to bring back Andurien. It would be an obvious choice for Andurien to attempt to eliminate the Mariks. Let us look at the facts pro and con.

On the day before the fatal June 1, there was a meeting of Andurien diplomats with Janos Marik, trying once again to get him to recognize their independence. As the vid tapes show, he had them thrown out with orders that they not be readmitted. If they tried to force their way back into his presence they were to be shot as rebels. This certainly shows declining trust in the relationship between Janos and the Anduriens. Other evidence of Andurien involvement was that just after the bombing when, by Duncan Marik's order, the Andurien Consulate was raided, orders were found signed by Dame Catherine. The orders directed the Anduriens to "use any means possible" to dissuade the Captain-General from attacking the Duchy of Andurien. One of the maids in the Marik Household had relations there, and had recently returned from a trip to the Andurien Duchy. The final piece of evidence was that a coded radio signal had been sent out from the Andurien Embassy, picked up on a random sweep by SAFE, supposedly to the ComStar facility on Sian. According to ComStar spokesmen, no such signal was received. The explosives used in the bombing were determined to have

Duncan has also died in the attack, their would have been no top-ranking military commander to lead the vast attack needed to successfully bring Andurien back into the Free Worlds League. A second advantage: the other Succession Lords would have had to take notice of Andurien as an independent State, and to consider the possibilities of making agreements for trade and defense with this new, potentially dangerous realm.

Since the Anduriens claim that they did not commit this act, we must look at the reason why the Duchy would not have committed this assassination.

Andurien may have been unafraid of the might of the Free Worlds League, figuring that she would never have to face an all-out war, as House Marik would need to reinforce her borders in force before it turned its attention to an internal fight. The Free Worlds has too many greedy neighbors. As for a limited war, let us turn to the documents found in the Andurien Consulate. A battleplan titled 'Lone Wolf' was found there, mentioning an alliance between the Duchy of Andurien and another unnamed source, a mutual defense pact against the Free Worlds League. It is believed that the source of this extra defense is the Magistracy of Canopus, a large realm in the Periphery.

In light of all the evidence Andurien seems to be the perpetrator of the deaths of Janos Marik and his sons Duggan and Thomas Marik. Duncan Marik has been voted the Captain-Generalcy with the support of his brother Paul. His first act as Captain-General was to declare war on Andurien. Spokesmen for both the Duchy of Oriente and the Principality of Regulus say that this time these regions will not wish to be excused by the Home Defense Act from fighting their former friend. Duke Christopher Halas has ordered formal mourning throughout his realm for his good friend Janos Marik. Kirc Cameron-Jones, heir to the Principality of Regulus, intends to join the campaign against Andurien in the capacity of fighter pilot with his regiment, the First Regular Hussars. Captain-General Marik has vowed not to let the murderers of his family go unpunished. Like his ancestor Gerald Marik, he means to go to the Duchy of Andurien to insure that rebellion shall not come from that direction again for a very long time.

BattleTechnology Interviews

General Tor Miraborg, Varldherre of Gunzburg, Military Commander of Radstadt Province

Rasalhague's Iron Jarl

This interview with General Tor Miraborg took place in hospital on his home planet of Ginzburg.

Shortly after this interview, it was announced that General Miraborg had been given the title of Varldherre (world lord) and made commander of the province of Radstadt. This makes him one of the three top men in the new civilian government of Rasalhague.

Tor Miraborg is a muscularly built man of forty one, commanding in presence and severe of manner. He received me seated in his wheelchair; he wishes it known that he will remain unable to walk from this time forward. He does not wish to discuss the matter further.

General Miraborg looks like one of the old jarls, warleaders of free men from the days of his Viking ancestors. His troops in fact refer to him as the "Iron Jarl", a reference to his toughness as well as to his firm grip on his command. He has a healing scar on his cheek; he is beginning to go grey. The General speaks English fluently, but it is clear that his primary language is Swedeneese, that unique colloquial combination of Swedish and Japanese which is Rasalhague's gift to colorful speech in the Known Sphere. We have not edited out the occasional un-English elements in order to keep the flavor of General Miraborg's speech.

BT: Thank you for agreeing to this interview, General Miraborg. May we inquire how your recovery is progressing?

Miraborg: It is as well as can be expected. The injuries were severe.

BT: Would you mind telling our readers how you were wounded, Sir?

Miraborg: During the Ronin Rebellion I was in one of our bunkers directing a combat which got...in the expressive English idiom...a bit hairy. An Archer unfortunately let off

some stray LRM rounds which hit the bunker. In the process of aiding people in getting out of the wreckage, a Steiner laser hit one of the supporting Pack Rats, and debris from that wreckage hit me in the back and across the face. And, well, I kept directing the battle as long as we could. And we won.

BT: If you are to have a scar, this is a distinguished one. It looks rather like an old-style dueling scar.

Miraborg: Why not? I can hope to start a great tradition! They are badges of honor, scars.

BT: How did you first join the Tyr movement?

Miraborg: In prison. With our leader Haakon Magnusson — we became friends there. That was after his dealings with the SPA; we spent several years in prison together. Then he and I joined the Freedom for Alshaine movement where he was called 'Silver Fox'. (This identity is still not too widely known). We trained them to be a good army operation. That was all before Tyr. In 3029 the Lyran Intelligence Corps contacted our group. We went to a series of special meetings that lasted three weeks. There we joined the Tyr.

BT: So Prince Magnusson and yourself were not founders of the Tyr?

Miraborg: No, the Tyr were already in training for a time before that. As a matter of fact, Alshain's Freedom Fighters were influential in 3026/27 in attracting the Draconians view to Alshain. Skilled Rasalhaguian mechwarriors were not observed as they quietly left the Draconis Combine for Lyran space. Purely a coincidence, you understand. I'm told BattleTechnology is publishing a small document by Johan Sorenson which explains the history of Rasalhague's founding more fully.

(This was news to me at the time of the interview. Are we doing that, Mr Carter? Yes, see page 39.)

BT: Where were you during the 4th Succession War?

Miraborg: We were training underground movements to

harrass the Draconis Combine during the Fourth Succession War. We were...where we were not expected to be. We were able to turn much of the battles into our favor. That is in deference, the Lyran Commonwealth, much of this action is still (what is the English?) ...classified.

BT: What can you tell us about the Tyr agreement with Archon Katrina Steiner?

Miraborg: The agreement was that the Tyr were to assist the Lyrans with retaking certain worlds — all the worlds of the original Principality of Rasalhague. Those worlds at the end of the war were to go to us. Now we must thank Theodore Kurita for his generosity in giving us so many of these worlds so recently, worlds which were not conquered during the war. I do not know if you are familiar with Duke Kelswa's treachery and double dealing?

BT: That was to be my next question.

Miraborg (with his rare smile): Then, please, ask your next question.

BT: Why was Duke Kelswa of the Tamar Pact allowed to take over the Tyr planets?

Miraborg: He believed that that was the best policy for the Lyran Commonwealth, to have his troops occupy and control those worlds. He did it completely against the wishes of the Archon Steiner and ... he paid. Admittedly, many of us were thrown into prison because of it. We were soon released by the Archon. He was, I believe, suitably chastised for his attempt to put his own people into Rasalhague worlds.

BT: Despite the Lyran agreement that the Tyr were Rasalhague's government in exile, the worlds in Lyran hands were still not handed over to the Tyr, were they?

Miraborg: No, because the Lyrans were under their official belief that the Kuritans would be mounting attacks at any point to take back those worlds. So of course, as history proves, the Kuritans did not. They gave us the worlds we wished, plus more. That forced the Lyrans to keep their agreement with us.

BT: What was the agreement with Gunji no Kanrei Theodore Kurita that allowed a 'bloodless revolution' to create the Free Republic of Rasalhague?

Miraborg: Well, relatively simple. A little harsh, but...We agreed that one half our trade for export would go to Kuritan interests. In return the Kanrei was to give us our traditional worlds. He was in fact so generous as to give us other worlds as well. But along with this goes a formal pledge of military aid



Gen Miraborg (left) and friends, Spring 3029

until we could get own own military, other than the Tyr regiments, operational. As we could see during the just completed Ronin Wars. And there is a minor unofficial reason also which is — the Free Republic of Rasalhague would make a good buffer against invasion for the Combine. Especially considering the recent marriage between the Steiners and the Davions. He would not have to fight on such an extended border with the diminished forces he has left even now, five years after the wars end. He could concentrate on two separated fronts instead of a continuous front around the Inner Sphere side of Draconian space.

BT: What do you think is the basic cause of the Ronin Rebellion that erupted shortly after the founding of the Free Republic of Rasalhague?

Miraborg: Those now considered ronin, including Marcus Kurita, believed themselves to be loyal to the Kuritan state and protectors of Lord Takashi. Our realm, now become our republic, has been freer than most of the Combine, or has always had a most independent mind set. People like us could have becomes enemies in future time. The ronin wanted to ensure that we would never be an enemy. Though as long as there is a Kurita on the throne we shall never be enemies of the Draconis Combine.

BT: Will the famous Rasalhague Regular Regiments continue to fight for the Draconis Combine?

Miraborg: Not as many regiments or in such numbers as before, but yes, they will. They would probably be joining Alshaine Regular units rather than continuing as *Rasalhague*

Regulars. We have our own units forming now.

BT: What will become to the existing Rasalhague Regular Regiments?

Miraborg: They will stay with the Draconis Combine until their terms of service are up. This is the only honorable thing, to finish their service before returning to decide. If they wish to, they may then resume their rightful citizenships in the republic.

BT: How do you rate the Free Republic of Rasalhague's preparedness during the Ronin Rebellion?

Miraborg: We had but recently formed. With the exception of the Tyr, trained by the Lyrans, the *Kungsarmee* units had no combat experience, but we did receive our baptism of fire rather quickly. In small unit action, we have some of the best.

BT: How do you rate the Free Republic of Rasalhague's morale at this point?

Miraborg: Both military and civilian morale is high be-

which have been seeing so much of the death and destruction and the horrors of war will be built back into a more environmentally secure and quieter situation, so that we can live up to the policies of the old Principality of Rasalhague, that all worlds should be ecologically secure and their people should be happy. We will continue with the one-for-one, the 'Even Scale Policy'. We will hope that this time peace will last for our lifetimes, but I doubt it. But we will be protective of our borders and our families and our lives from any invader.

BT: What problems do you foresee for the Free Republic of Rasalhague?

Miraborg: Problems? Problems! That is not really my end of things. Some problems may be ensuring that our home units are adequately trained. And perhaps doing the 'Even Scale Policy' will bring its own problems with bureaucracy just at first. We must hope that with time this will clear up. And, well, we'll probably have minor problems like pirates raiding us for water, or the occasional mercenary groups like those

Mercenaries are in the politics of the thirty-first century... a necessary evil....

cause Prince Magnusson is doing a good job. Leadership in the present time of peace will be strong.

BT: Do you feel that the recent marriage of Duke Ryan Steiner to Duke Kelswa's daughter Morasha consolidated a threat against the Free Republic of Rasalhague?

Miraborg: It certainly could be. You must know that if they decide to attack us, with our 'Even Scale' policy of trade equality between the Lyrans and the Draconians, the Tamar Pact would be breaking a trade agreement. We would have Lyran support in repulsing any attacking force they could muster against us. We do not believe that they are a threat to the sanctity of the present peace which pervades the Inner Sphere.

BT: Speaking of marriages, you are reunited now with your family now for the first time in over two years. Do you find them well?

Miraborg: I suppose your readers require to know about my family life? We have a wonderful little daughter, Tyra. She will grow up to be, probably, as headstrong as her father!

BT: What direction do you see our new republic taking?

Miraborg: Well, we will be making sure that the worlds

Kell Hounds attacking our worlds for personal profit as they did in 3010 in Skandia. These are about the only problems I can see — at this point in time.

BT: Under Kurita rule, there was a discrimination *for* those of Oriental descent. Do you feel that there will now be a backlash of discrimination *against* them, as some critics foretell?

Miraborg: The people of Rasalhague have always been isolationist themselves. But those people who have been part of the community on our worlds, those people of oriental-heritage minority will probably find that life won't really change too much for them. It is a problem we must look into. They will receive more freedoms — probably a change for the better. Only time will tell.

BT: And the so-called 'Lyrans Half', the planets that until recently were under Steiner influence? There are already charges that they will be left out of the new civilian government. What will be their lot in the Free Republic of Rasalhague?

Miraborg: Well, much as those in the worlds which *Kanrei* Theodore has so easily given up. Each world would have a

government which meets with its *Varldherre*, and decides basic dictates for the entire province. The three *Varldherres* communicate this to the Prince. As long as they will take part in our government and do not go to the more violent ways of our past to make a statement, their voices will be given equal hearing as those from former Kurita space.

BT: Now the difficult question. Many of BattleTechnology's readers are mercenary soldiers. What is the role of mercenaries to be in the Free Republic of Rasalhague?

Miraborg (with a steely look): Very minor. (Long pause) You wait for more? Mercenaries are in the politics of the thirty-first century a necessary evil. The majority of them are little children given big toys to play with. Very few have learned the honor which it is to be a true warrior. There are exceptions, but very few of them. We will hire them when we need them. If they persist in certain actions of the past, they will.. not be liked by the people of Rasalhague.

Mercenaries are one of two types: the majority, at least in the thirty-first century, are completely and utterly incompetent. They are worse for the side that hires them than for the enemy. The other type are actually good soldiers. These are very few. These are dangerous, because they work not just for money but to gain power. This makes them worse than the incompetents...

BT: Is there anything you would like to say to the readers of BattleTechnology? The readership spans the entire Inner Sphere and most of the Periphery.

Miraborg: Yes, actually. Now that a sort of peace is achieved, after Davion's quest for more territory, it is time for real peace. There is time to put our weapons away, time to live as brothers instead of as enemies. We must bring back that which has been lost — knowledge and technology — both in order to improve our own lives, and to improve those worlds we live on. So they can work with us instead of as many do, working against us.

The government will honor our contracts, but I will not guarantee the people

BT: I must persist, sir. How will mercenaries be treated here?

Miraborg: If they are honorable and act as true warriors, they will be accorded the courtesy they need. But no more and no less. The people of Rasalhague have had bad experiences with mercenaries — for example, the Kell Hound action in 3010 in which the unit created a shallow sea in what had been an important mining operation, and so depressed the economy of Skandia for several years, just so they could get a DropShip. So the government will honor their contracts, but I will not guarantee the people.

BT: And yet rumor has it that the government intends to hire those same Kell Hounds. Can you comment on that?

Miraborg: Just because they play irresponsibly with the ecology of a world and the economics of a world? They can still be hired to deal with Periphery scum.

BT: In Tyr meetings you were known to quote Macchiavelli about mercenaries.

Miraborg: That is true...You wait, again? Yes, I believe in Macchiavelli's saying that a Prince should not trust mercenaries. I quote

BattleTechnology's local stringer, Holger Andersson, makes no pretense of objectivity. He used to have the nom-de-guerre (war pseudonym) of 'Jaspas'. Precious stones were the codenames for leaders like Miraborg and Prince Magnusson, semi-precious stones were the codenames for district leaders, and names like 'Onyx', 'Agate', and ...'Jaspas' indicated city or small planetary state leaders of the Tyr movement. He has a wholehearted admiration for the movement and its leaders. He has only the highest hopes for the new Free Republic.



Not Always a Great Notion

Tales of the Cobalt Coil #2

by S. Jansfield

It wasn't a typical day in the Cobalt Coil. Not that anything on Solaris is truly typical. But the Coil tends to be different from the rest, more peaceful, more predictable. We don't get a lot of fights, much less lethal ones. If you want to blood your knuckles or knives you go to a place like Bronski's or Mongo's Fun House. If you want to drink a few of your favorites in a pleasant low key atmosphere without the glitz and excessive prices of, say, Valhalla; you come to the coil. We're a family bar, though we specialize in PPC's.

Which made what happened all the more distressing.

The fact that I was there and the sun was out made it odd enough. Len, the day man, was off tending to some personal business (I wondered what her name was and, knowing Len, what her husband's name was) so as head bartender, I was filling in by filling glasses when I should have been home filling my bed. I hate double shifts.

It was a different crowd by day, same feel but different faces. We got a lot of Techs on break from the nearby arenas, gamblers pumping the Techs for inside information, and a few 'Mech pilots getting set for their next bout. Everything felt friendly, even the gamblers knew not to press their marks too hard in the Coil. I'd just set out a new round when they walked in.

We knew them by the red spiked hair and pseudo-leathers, three of the latest youth gang, Satan's Jackals. Groups like these popped up over night, then ran amok for a few days or weeks until they inadvertently moved on something too big and the local Yakuza reacted. Sooner or later another group would surface bearing some nihilistic name and the cycle would repeat. So far the Jackals' number hadn't come up.

They came in smiling, showing off filed teeth that I suppose were intended to look menacing. It just made me remember

the old adage about how God must love fools or why else would he make so many of them. I've known true pain; only a complete idiot would do something that painful voluntarily (unless they'd doped themselves to the ears, which is equally stupid). One of them sauntered up to the bar while his two buddies began working through the tables obviously looking for someone. I gave them their space. The Coil's fairly permissives; all we ask is that you pay the bill, keep the peace, and respect the privacy of others. I suspected they were going to break at least one of the rules.

"Filtered water, please," Moe said in a faintly lisping voice; new to the teeth, I suspected. I'd dubbed the spokesman 'Moe', and his companions 'Larry' and 'Curly' in memory of the great ancient Terran socio-political satirists.

I poured water through the carbon filter, then gave it a flash of ultra violet light; only the best at the Coil. I set it down in front of him on one of the good napkins.

"That'll be one centi-C bill; exchange rates for house currencies are on the board," I said, gesturing at the blackboard over the bar.

He didn't respond, just downed the water, then turned to see how Larry and Curly were doing. *One out of three*, I thought. His two companions had gravitated toward a corner table where a lone, quite attractive, middle aged woman sat pointedly ignoring them. I knew her vaguely. She sometimes came in at night. Always alone, she seldom talked and never smiled. By her accent and manner of dress, I'd always assumed she was from the Cappellan Confederation, but she never volunteered much information. She drank heavily, but without any noticeable effect. Occasionally she examined a bit of twisted metal she kept in a small bag at her throat.

Moe left the bar to join his buddies at her table. Everything got very quiet.

Here comes three of three, I thought.

"Ling Mc Cormak?" Moe asked. The name stung her before she could conceal her reaction. "Tolver sends his regards."

While Ling was still staring with rage at Moe, Larry drew a butterfly knife. A lot of us in the bar started to move, but whatever Ms McCormak did before she came to Solaris must have included a lot of unarmed combat. I never saw the blow that broke Larry's arm, but we all heard the crack.

Moe was almost as fast, thought not too bright. He had a laser pistol out of his coat while Larry was still crumpling to the floor. Curly just looked confused, as if he couldn't figure out how Larry's arm had acquired a new joint. Moe was about to fry Ling when from somewhere in the bar, a pistol spoke. It took me a moment to realize that it was mine.

I've carried a gun for some time, not so much for breaking up bar fights, but because I handle the receipts for the Coil. Recently I'd picked up one of those new Thornhill Arms Vipers; this was the first time I'd fired it outside the test range.

It did a good job.

A substantial section of Moe's chest blew out in a spray of crimson. He hit the floor and everybody else froze, staring at the smoking gun in my left hand. The barrel gravitated to Curly.

"I suggest you take your friends and get the hell out of here before I really get mad." Curly got the message. He helped Larry to his feet and the two of them, Larry using his one good arm, dragged the bleeding Moe out the door. He left a long red smear on the worn tile floor. Still everybody watched me.

In a place like the Coil most everyone has a skeleton or two buried in their past. Something like this exhumes them suddenly and tempers get very short. McCormak looked around with naked fear in her eyes which the rest of the crowd picked up like a broad beam ComStar broadcast; I could feel the panic building. When a hunted animal finds its last refuge invaded, it gets vicious. A lot of people think of the Coil as their retreat.

With exaggerated slowness, I holstered the gun. I keep it in the small of my back where it won't get in my way. Then I got a bag of poly-dust we use for cleaning big spills and proceeded to blot up the blood stains. The tension was still mounting, nearing the flash point. I returned to the bar and picked up a stick of chalk.

"Well, one bad idea deserves another," I remarked with forced levity, very aware of the eyes burning holes into my back. One the corner of the board, I wrote those three little words that mean so much in the Coil, "PPCs, Half Price".

"Furthermore, as head barkeep of this establishment, so mandated by our lovable proprietress — raise your glasses to her, ladies and gentlemen — I offer this challenge. If any of you can come up with a legitimate variant of that drink so appropriately named for the Particle Projection Cannon; a variant which I do not know or cannot guess with reasonable accuracy how to make, I'll stand a round to the bar!"

That was all it took to remind them this was their place. So what if it wasn't Friday night, let the owner complain. I was saving a lot of customers.

I started pouring PPC's, and somehow word got out that Friday night at the Coil was arriving Tuesday afternoon. A lot of regular showed up and a few newcomers found out what half-price night (or afternoon) is all about. I only got stumped once. If you are ever called on to make a Redjak PPC, just cut your grain alcohol with coffee liqueur, then cool it with a few chips of dry ice; "as cold and dark as Ryan's heart", the man said.

The atmosphere livened up, and as sure as the PPC's were going like ten C-bill rockets, someone started in with a story.

In deference to the day's excitement, the subject of bad ideas developed. The stories ran from cases of poor judg-

ment, like the Major who tried to lead a command lance through a peat bog, to the mind-numbingly ludicrous, like why someone would try to put a nose-mounted Tomadzura autocannon class twenty on a Sparrowhawk Aerospace fighter. We were getting a good chuckle out of that one when Ling took us into the world of high-tech slapstick.

She'd just polished off a Redjak PPC (it had become the drink of the hour after my ignominious defeat), and set her glass down with a thump. We all looked over. She was reported to be a first rate freelance Tech who had, according to very reliable rumor, turned down impressive offers from some top flight 'Mech units. I guess she just preferred the anonymity of Gameworld; made sense if she was running from something, and who of us wasn't. We sensed that the thump marked the beginning of another tale. And the old timers knew it would be good. It always is, when someone opens up for the first time.

"I spent a lot of time Teching for a unit called Clave's Centurions," she said, the ghost of a smile playing on her lips. Without being asked, I fixed her another drink. "In its time it was a respectable sized unit. A full company complete with air wing. We were serving a long term contract in the Free Worlds League. We'd pulled garrison duty on Bridgid's Bounty, a small agricultural world out towards the Periphery. Bridgid was not very big or strategically located, but it hadn't seen a lot of combat. As a result, it was a very rich food source.

Bridgid was originally colonized by descendants of an ethnic subgroup of old Terra, Scottish Highlanders. By your faces I can tell some of you know of this odd race. Fiercely proud, independent and clannish, they did not like outsiders; they never forgave House Marik for their forcible inclusion in what they sardonically called the Puppet State League. Without a good sized garrison to keep the locals producing, the food shipments off planet tended to be erratic at best. But then, Bridgid was so far off the beaten path, old Janos didn't want to station a top flight House unit there, so he used mercenary 'Mechs and a contingent of regular ground troops. There was not much a bunch of warlike farmers could do against BattleMechs, so things were peaceable, usually.

The fire lance of our unit was led by one Captain Yoshi Decchio. He was only an adequate mechwarrior but he had excellent connections, which explained the command. His machine helped. It was a mint condition Thunderbolt with the large laser replaced by a salvaged Lord's Fire PPC. He'd painted it sunset red and named it 'The Killing Fury'. It was a good war machine. Blake's fire, a Thunderbolt with a faintly competent pilot is dangerous. All he had to do was leave it alone and he would have had a first rate fighting machine. But old Yoshi thought he was much more than a hot 'Mech pilot, he was a Tech as well. And not just any Tech; he was a creative one.

Now, you're all grinning, but let me say I have known

some warriors who were darned good Techs. Yoshi was not one of them. The entire Tech section spent a lot of time trying to undo Yoshi's creative efforts, and not just on his 'Mech. A few of the other pilots confronted him with weapons drawn warning him to stay away from their 'Mechs. After that he restricted himself to that poor Thunderbolt, and undefended camp equipment.

Once he rigged up the field kitchen saying it would now fix an entire meal with the transmission of a preset radio code from the battlefield. It took us three days to clan up from the test run; by the time we finally left Bridgid we still hadn't received half of the replacement equipment we'd requisitioned. But it was the Thunderbolt that took the worst of it."

She paused to sip her drink as we all smiled, remembering the oddities in human nature we'd run across.

"One thing always irked Yoshi," she continued. "With all the firepower a Thunderbolt could discharge, it struck him as

He would clump his weapons

unreasonable that any but the heaviest armored machines should be able to withstand even a single volley. He thought about it, and came up with a rationale. Damage spread.

Due to the decline in computer technology during the course of a battle, damage tends to get spread all over the surface of a 'Mech. Unless you get a lucky head shot, most weapons will chew armor for a while before getting through. Of course, I'm talking about the heavy and assault 'Mechs, but the same principle applies to the lighter machines if you talk about the lighter weapons. Now if you could find a way to place your shots more accurately you should significantly shorten your battles; how many times have you seen a machine come back from combat, mauled but still running? Ever thought what might have happened if even half that total damage had been applied to a single location rather than being spread all over the 'Mech? Yes...frightening thought!

But how to solve the problem of damage spread? It was a good bet that targeting technology wasn't going to advance just because Yoshi wanted it to, so he put that 'great brain' of his to work on the problem, the same brain that created the one-shot camo-pattern paint bomb! But this time he actually made a few rational conclusions. A large part of the problem was the actual dispersement of the weapons themselves. The targeting computers of today are not near as fast as those of the Star League. And combat is a high speed affair. Those computers have a very difficult time working out range and

trajectory solutions from a number of different firing points in the short time between volleys. When you think about it, it's a small miracle if several of your weapons manage to hit the same 'Mech sized target at ranges in the hundreds of meters. So Yoshi decided to give his targeting computer an easier time. He would clump his weapons in one area.

Since that PPC was already on his Thunderbolt's right arm, it seemed the place to load up. He managed, with lots of work, to transfer all three medium lasers to a blister mount on the right wrist; it sort of balanced the weight of the PPC. Still not satisfied, he moved the Delta Dart LRM to the right shoulder. He left the machine guns on the left arm, considering them useless in 'Mech combat, and kept tinkering with the right torso SRM. He never found a place for that. Of course the right arm was not designed for all this added weight! He stripped off some of the armor, then added a lot of internal reinforcing that strengthened the arm — but drastically cut its range of motion. To effectively fire, he had to brace the right arm with the left hand, sort of like a standard pistol stance. The Captain was inordinately proud of his 'innovation', predicting it would herald in a new era of 'Mech design. We all smiled and went about our business.

Test firing seemed to support Yoshi's claim. On the range, one shot from that right arm combination proved to be devastating; he could accurately place the missiles and PPC on a single target. This made Yoshi more insufferable than usual. He swaggered around offering to help the rest of the unit warriors modify their machines, even suggesting that the fighter pilots move all their weapon systems to the nose of their aerospace fighters, so the navigation computer and the targeting system could work in tandem. We all tried to ignore him, knowing that the success of any 'Mech variant is only proved in one place, the battlefield. Three weeks later, the new improved 'Killing Fury' got its field test.

We later found out that the locals had pooled their funds and hired a mercenary unit called Force Delta. It was a company sized 'Mech unit with heavy armor support. The first we knew of them was when they soft landed less than twenty clicks from our base. The air lance went out and came back tattered; they had good air defense. Meanwhile our 'Mechs got ready for the upcoming assault. Capt Decchio's fire lance was to take point defense in the hope that heavy defensive fire might slow their advance or even force the invaders off-planet. Old 'Killing Fury', listing noticeably to the right, moved

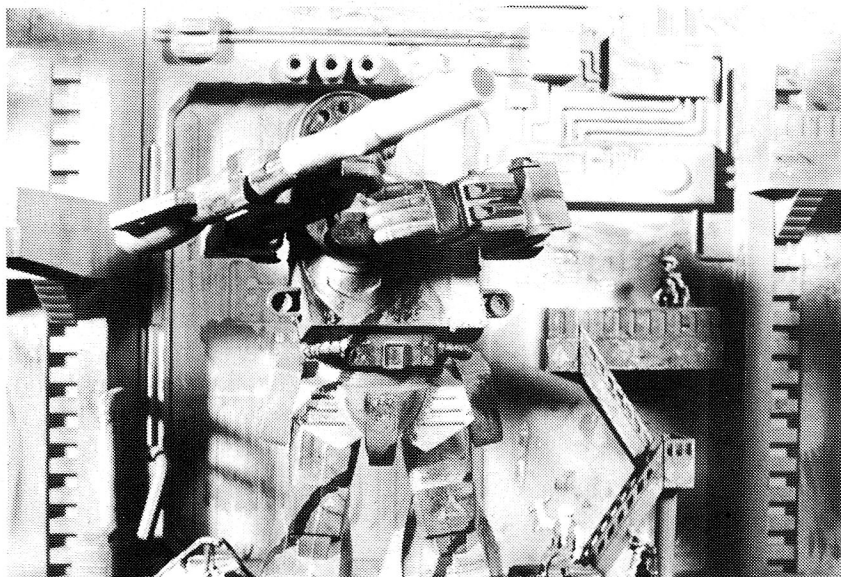

Yoshi triumphant in the Mech Bay

out with the Catapult and two Shadow Hawks that filled out his lance.

The area for the expected engagement was a perfect shooting gallery, a broad expanse of nothing but fields and grass that stretched for dozens of clicks in each direction. It had a narrow river flowing through it about five clicks from our base. Yoshi took point, his 'Mech waist deep in the river, with the Catapult about forty meters behind him and the two Shadow Hawks flanking out sixty meters to each side. The other lances were out behind and to the sides of Yoshi's lance to prevent any circling and the remains of the air lance were on base defense. We non-combatants were clustered around the vid-links watching the remotes from the battlefield. And Delta Force came.

All three lances, plus their armor, came right up through the center in the hope of breaking through. Our two outer lances began moving up, but it was a sure bet that the fire lance was going to be fighting unsupported for ten minutes at least. Yoshi loved it. Delta Force was comprised of light and medium vehicles; the biggest thing they could field was a lone, rather battered, Wolverine. But they were brave. Yoshi and the Catapult opened up with long range missiles at max range and Delta Force kept coming. Once they got close enough, Yoshi stopped with the LRM's and cut loose with his good right arm. The Shadow Hawks sniped from the side and the Catapult kept firing, but Yoshi led the fray.

For awhile it seemed he might win the battle single handed. You see, the Captain had figured that by standing in water, he could use that massive battery of weapons fre-

Incoming!!

In the next,
action-packed issue
of BattleTechnology...

- The Fox Eats Crow:
— Hanse Davion Loses a War
Theodore Kurita Wins One
- The Useless Mech:
— A Tale of Theodore Kurita
and the 4th Succession War
- House Marik
— A Private Succession War
- The Edge of Night
— A. Mechless Mercenary Unit
- External Stores
— what & where
- BattleMech Engine Efficiency
- More Unusual Mechs
- Plus other feature articles;
regular columns; battle simula-
tions; news from the Periphery
news from the Inner Sphere...

and much, much more

Don't miss it!!

quently without pausing long to cool. So he kept firing away, trusting the water to keep him from overheating. And things hit by that barrage stayed hit; yes, the targeting was working better. His shots tended to cluster nicely blasting whatever they hit into rubble. He was having a grand old time.

The heat sensors by his fusion engine told him everything was under control, the magnetic bottle was stable, and plenty of energy was available for weapons fire. The few shots that made it to him were taking off bits of his armor, but Yoshi was used to that; evasive maneuvering never was Yoshi's strong suit, he preferred quick and brutal confrontation. Then the heat sensors on his right arm began to register a rapid heat buildup. He must have assumed it was a malfunction because he switched that sensor sub-system off so it would not give incorrect data to main computers and prompt a shut down. Everything else was fine so it had to be a malfunction, right? He kept firing, not noticing his accuracy was slowly degrading.

Our remote I/Rs showed what was going on but nobody bothered telling Yoshi. Officially, we all said that his onboard systems must have let him know the situation, and we did not want to distract him during combat. Actually, we all saw it coming, but we resented Yoshi enough to let him enjoy the fruits of his labor. What, you ask, was going on?

Well, the I/R imaging showed a massive heat differential developing in that old Thunderbolt. The main body was running a lukewarm yellow that cooled to green where the 'Mech touched water. But the right arm was bright red. I see some of you are confused; you're thinking like Yoshi and haven't studied your thermodynamics. A BattleMech does not act like a vacuum bottle with an energy source in it. Once the source is turned on, the energy level is constant with respect to distance in every direction. In anything but a vacuum, heat has to move from one thing to another according to the principals of heat transfer. Yoshi, while he reinforced the structural integrate on his 'Mech's right arm, hadn't added any thermo-flow systems to help vent the waste heat through the 'Mech's heat sinks. He was generating heat in the right arm a hell of a lot faster than it could passively flow through his machine.

All it took was a large laser hit on his right arm at the same time he fired off that mass of weapons. The side of his machine glowed for a moment, and then since the power relays for all those weapons were in the right shoulder, *the arm fell off!* You could see it happen. The titanium bone heat fractured. The armor plate, softened from the blast furnace temperature, flowed like wax. The severed arm hit the water in a cloud of steam, and I swear to you that 'Mech took on a dumfounded expression. Yoshi just stood there in shock, staring at the slagged stump on his right shoulder, while the rest of the unit finished pushing the Deltas off planet.

Yoshi was in shell shock for days and never fully recovered. Some said it was brain damage from the residual heat he'd soaked up from the meltdown. But I think his ego was just shattered beyond repair. The Thunderbolt was history. Enough heat had leaked into it to destroy about all its internal systems. We scrapped it and used the proceeds to retire Yoshi from the unit. I don't think he even noticed us giving him a standing ovation as he shipped off Bridgid. We just wanted to give him a 'hand!'

A ripple of laughter ran through the bar. I picked up Ling's glass thinking that a story that good deserved a free refill. I'd known some would-be innovators in my time, but few came to ends as spectacular as Yoshi. But Ling wasn't quite finished.

"You know, I hear Yoshi never even sought another 'Mech, just passed quietly into the ranks of the Dispossessed. I guess he couldn't face the thought of 'arming' up again."

Comrades At Arms

by Menig Daniel Horgunse

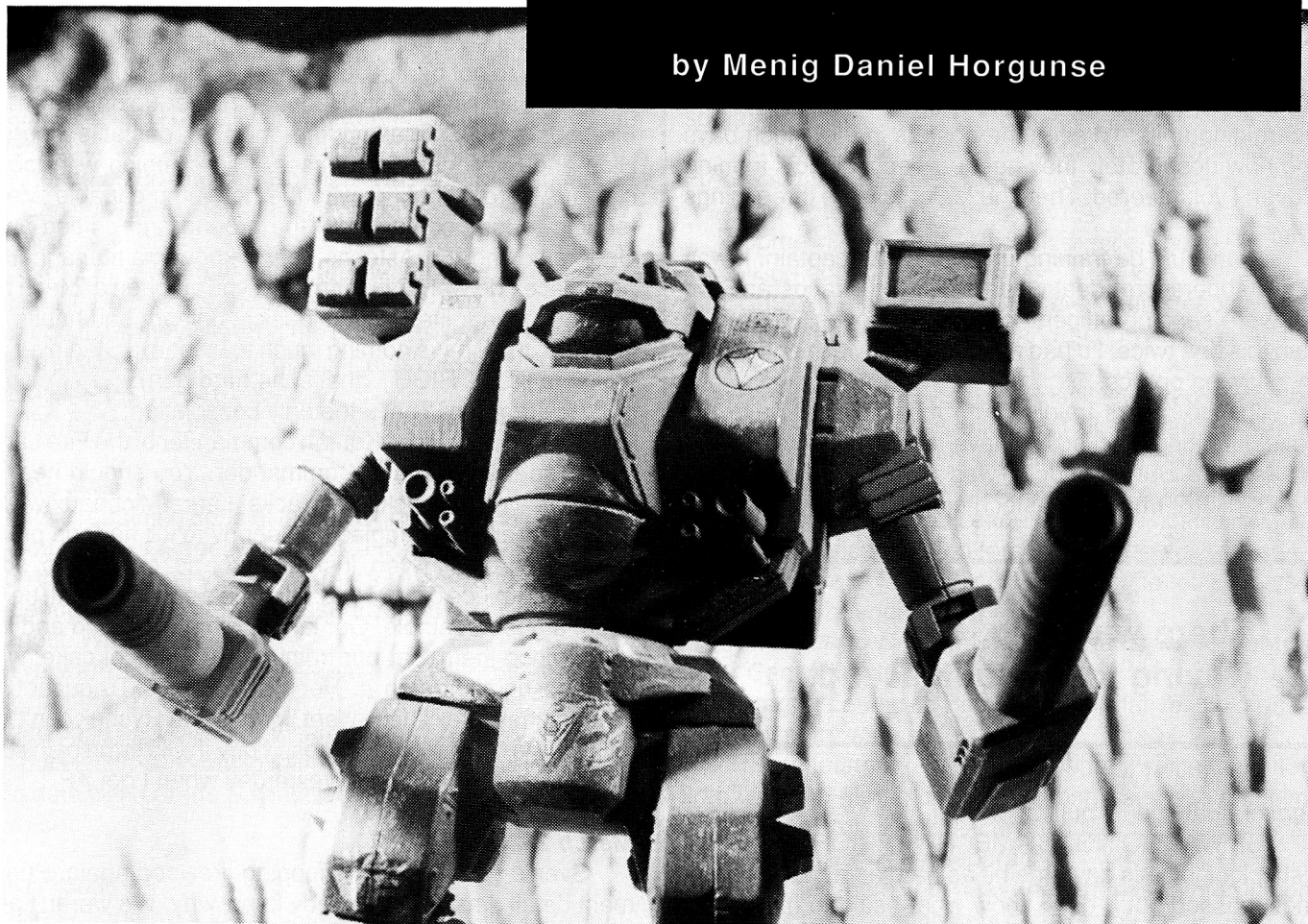

January 19, 3035, diary of Daniel Horgunse, Tyr/Kungsarmee Second Regiment, Training Company Alpha, Recon Lance (how I love to write that)

I'd always wanted to be a Kavallrist, what you call a MechWarrior. I spent all my quarter-Cs on the simulator games when I was growing up. Not the gulping smile-faces, not the lance combat on kangaroos, the games as much like 'Mech piloting as possible. *Minnesota Tribe Raid*, *Star League Divided*, *Davion for Glory*, even the can't-win *Hohiro Vanquished*; I can tell you their strategies even today.

As a gawky teenager I spent my prentice wages on the training sims while I worked with my dad, who is an Astech at a Tyr secret base, servicing the scrap-heap 'Mechs which were all the Tyr saw for equipment, particularly before the deal with the Lyrans. Say what you can about the Elsie, old Katie treated us decently when it came to equipment. I worked on the 'Mechs I loved and hung out with the pilots. (Well, I went for coffee and listened to their stories.)

Just before the end of the Fourth Succession War, there was a raid on Skokie. My Uncle Fredrik's lance was one of the defending units. They did a classic combined ops canyon maneuver, with hidden infantry, VTOLs, the whole bit. They placed a juicy ambush at the end of a long river canyon. Between them, nine enemy 'Mechs were salvaged. One was a Panther which looked as if it had been through a meatgrinder. Ammo explosion took out the left arm and most of the center torso and killed the pilot. I was assigned to work on it. *Javla*, it was a beautiful machine! I had to rebuild the arm actuators almost completely. It is *possible* to take the central socket from the left hand actuator of a Clint and do a lot of reshaping on it and make it fit a Panther! I've proved it. It only takes two months of night work! I put in a *lot* of night work, and most of my paychecks. I kept my simulator training up, so my dating was limited to women who liked picnics — or holding wrenches. It took me over a year to fix Sluggo up. He'd taken a lot of damage. I got into the habit of talking to him during the long nights testing myomers — even

with the Thornhill MAS, you can't rush a myomer analysis! When he was done, I gave him a coat of blue paint with yellow trim to hide all that blood red — and felt a little lost.

Then the Major called me in. He asked if I'd transfer to one of the training units. I'd seen the posters in the 'Mech bays saying how desperately they needed Techs. Dad's training took over. I volunteered. Then the Major told me three things more:

1) I would be training under a Lyran captain. It was part of a supersecret deal where both the Dracos and the Elsie's were sending officers to train our troops. He had to explain this one twice; I'd had my head in a 'Mech and hadn't been following politics.

2) The others training with me would all have the battlefield training I lacked. I'd have to work like crazy to be even adequate. But he thought I was sufficiently motivated to succeed. (Huh? I had my Astech credential now; I was no

There was Hiro, waving to me to descend.

Robertson, but I could pull my weight.)

3) I WAS GOING AS A MECH WARRIOR. In training. The shock of joy this gave me hit as hard as a battlewound. I almost passed out. I don't know what I said to him. I only knew I had to tell Sluggo.

There seemed to be a lot of people around the 'Mech bay as I made my way to the back hanger. Suddenly I saw — Sluggo had a blue ribbon on him. And a label with *D. Horgunse* written on it.

Then I did pass out.

If you ever get everything you've wanted for years on a single day, maybe you'll do better at it than I did. I hope someday you get the chance, OK? Ja, I wore a grin like a vidshow country boy for a week. Then I said goodbye to everyone I'd ever known and Sluggo and I shipped out. Fierce joy and terminal homesickness clashed in my belly. Dad had given me a letter so he didn't have to say it all face to face. *When you feel inadequate — and you will — remember that you're twice the Tech any of them will ever be!* he told me. If I hadn't been studying so hard that whole trip, I'd have wanted to cry.

February 19, 3035

Our lance commander is the Lyran, Elizabeth Rychek. She's short, which is an advantage in a cockpit. I'm 6'1" myself; after one of her long night watches is over, I've got

kinks in places I didn't know I owned. She's softspoken; it took me an expensive week to learn that orders are orders even when they're not barked. She's even polite to us...but relentless. We train till we drop. Red Alert power-up drill. Run-and-Fire obstacle courses. Jump-and-Fire obstacle courses. Hide-and-Fire obstacle courses. Cliff climbing with lobster claws. Asteroid fighting, with the non-jump capable 'Mechs tending to lose contact with the ground and drifting away. Understudying the Astechs so we know maintenance (the only place I do well). Never mind if you've been a 'Mech pilot for most of your life. Back to basics; unlearn bad habits (I'm OK here, too. I have nothing much to unlearn). Start over and this time DO IT RIGHT (that's the hard part).

Hiro's worse. That's the only consolation.

Takashi Hiro is the Kuritan commander of the Fire Lance. He's also the Company Commander. You should hear the Fire Lance groan back in barracks. Laura Micheaux waving her hands around begging somebody to kill her and put her out of her pain. Sven just grunts and carves up some inoffensive piece of firewood. Well, he's senior Kadett, he has to set a good example. Our lance, Kimi and David and I, try to convince them that our training is a piece of cake; we're waltzing right through it. Her Catapult, his Trebuchet, my Sluggo; they're all such sweet 'Mechs that Rychek can't help loving us. The Fire Lance doesn't buy it. Silverton said some particularly pointed things yesterday when I got KP.

March 23, 3035

Sven's got us all out chopping firewood again. Punishment detail. I asked if anybody knew why. We weren't great today, but we didn't really mess up the way we used to. Apparently some reporter interviewed Sven, Rychek, and Commander Hiro. All together. According to Kimi, who was on office duty and overheard, Sven did his best wooden Kadett imitation and Rychek and Hiro sniped at each other. They're always correct; each owes it to basic self-esteem to keep one up on the other in courtesy. But staff conferences are so icy you could skate on it.

April 17, 3035

I passed my pilot certification. Rychek bought me a beer in town. She's actually kind of human off duty. Sven led the initiation last night. It was worse than the Astech certification party. Somehow or other it seemed logical last night to show them how the Astechs made me climb the mech I was working on. There I was, climbing Sluggo without using the access code to get stairs. I had a rope around his left shoulder; I was dangling about mid torso when I noticed the vocal encouragement from below had slacked off. I looked down, and there was Hiro, waving to me to descend. I let myself down so fast I took skin off of my hands. He asked for an explanation. It seemed to take a long time to tell. Sven was standing beside

me. He asked permission to speak. He told Hiro the whole story, how I'd been a tech for so long, that I'd never thought I'd get a chance to be a mechwarrrior, that he thought I'd worked hard and I'd finally got my certification, against some rather heavy odds. He even said he'd take full responsibility. Hiro looked us up and down. There was a long silence.

"Can you make it to the top, Horgunse?" he asked finally.

"Yes, Sir, I can."

"Prove it. If you make it to the head of your 'Mech," he paused, "then this never happened."

If you think they cheered me on before, you should have heard them this time. Yes, I made it, even more stylishly than the time before.

Oh, my head hurts!

May 16, 3035

Basic retraining done at last! We got a speech from Hiro, and both officers agreed to give us a week's leave. We went out on the town to celebrate. There's the base tavern, the PX, the alehous in town, the smorgasbord shop — we hit all the fleshpots. Wow.

We were supposed to get leave in Ymir, ninety klicks away, but there's some kind of emergency; we have to stay close to base and keep our whereabouts known at all times. That puts a crimp in your lovelife! I have a week with no duty and a date with Lorette Swenson for tomorrow. So life could be worse!

May 17, 3035

Life *is* worse. We've got incoming DropShips surrounding Jotunheim. Our air wing's gone already. We get to march upcountry. Lorette was understanding. That's nice. Somehow the town's homebrew seems more enticing than it did yesterday. And the barracks never looked so snug. Bag packed, ready to leave. I've checked Sluggo over for luck.

May 19, 3035 battle recorder transcription

Why does this place seem so familiar? It 's one of Skandia's rifts, broken sharply by glaciers, further carved by a roaring river; not deep but very swift. The rock walls reach= out of sight, broken by strata of rubble, in crumbly layers.

The Recon Lance under Rycek are advancing in a modified leapfrog, sticking to cover. Kimi can't pilot her Catapult as well as Hiro (gosh, he's good!) but she did a good camo job on her 'Mech; wherever she sets down, she blends. I'm still in blue and yellow. I loved my proud paint job once. Now I wish I'd stuck to mud! David...David's Trebuchet seems to flow through the terrain effortlessly. Hes seen combat before, of course.

"Bird One to Bird Lance," crackls my radio, "I/R caught a possible at the end of the valley. Hard to identify."

"Bird Two to Bird One," Kimi interrupts, "Positive I/R

readings. Some are 'Mech sized; some too small."

"Bird One to Bird Two, try to get a count."

"Bird Two to Bird One, three or four 'Mech size, a lot of something else."

I knew suddenly why this place looked familiar. Uncle Fredrik's canyon!

"Bird Four to Bird One", I say.

"Come in, Bird Four," Rycek's voice. I hope I know what I'm talking about.

"Could it..." my voice could have been steadier, "could it be combined arms? Mechs and scout vehicles or hover-tanks?"

"Bird One to Bird Lance. Possible mixed force ahead. Look out for 'Mechs, vehicle, VTOLs, infantry, whatever. Think 360 degrees, guys. But don't shoot your own!" On the private link, "Not bad for a wrench jockey, Horgunse!"

"Bird One to Dragon Leader. Possible hostile force. Heat signatures indicate mixed forces. Hovertanks, maybe."

"Bird Two to Bird One. MAD confirms. Heavys and Hovers. Maybe more!"

"Bird One to Dragon Leader. Seems we've got trouble here. Can you help?"

"Dragon Leader to Bird One. Affirmative. Hold position; we'll close up with you."

The simulators don't tell you what it's like to wait to be fired upon. We keep our radio transmissions to a minimum, things like "Forty klicks — two Condors, 10 o'clock!" "Two more, thirty five klicks, separating!"

Now I see them, four heavy hovertanks coming in from 10 to 2 o'clock, zigzagging so it'd make you dizzy.

"Bird One from Bird Two, the air is full of heat signatures. Something there besides..."

"Bird Two and Three, this is Bird One. Get lost, I repeat, get lost! Bird Four, they're going to peel and fire. Try to pick 'em off as they start their turns."

Somewhere ahead of us Kimi and David are going to ground. I'm trying to do the jump-and-fire sequence Rycek drilled us in. If you jump, they miss you. Zing, it worked that time. The second shot went by me too.

"Bird Four, *fire* when you jump!"

Expletives deleted from battle recording.

I jump *and firedmy PPC*. Naturally I missed. Rycek hits one; an armor shot, I think. Two more jumps till I was in the red...

From the Fire Lance I hear, "Dragon Two to Dragon Leader, ware infantry!" Sven' s voice. The Fire Lance had caught up to us — but the hostile infantry had gotten past us and was attacking them! The Condors had masked the infantry advance. I wonder uneasily how many there were of the infantry. Wondering, I missed my evasive jump.

Sluggo rocked wildly; I'd taken a hit on the right arm. I compensate frantically to stay upright. I see Rycek turn,



sight, and fire in one smooth motion. Her autocannon five blasted, right down his exhaust! A bloom of fire. One Condor gone.

"Dragon Two from Dragon Leader, one of my right side jump jets is hit. Attempting controlled landing. Stay clear." He must have made it because the next command was "Dragon Two, I'll take the right side clearance." The hiss of laser fire, and Sven's "Got my avalanche started, Dragon Leader. Looks like you did too. They're history!"

We're switching frequencies, preprogrammed, of course. Over our latest channel we get a voice from the enemy, a command and answer in Japanese. "*Hiro Okama, right flanking!*" "*Hai, Chu-i!*" The next thing I knew, our Captain Hiro's Catapult is rocking past me, unstable in the air, with one jump jet belching smoke. Laura's Phoenix Hawk is following, not too close. Why get eliminated by your own side? Why take to the air at such an appalling risk? The cadet that tried that would be washed out in a minute! But Hiro isn't a cadet; he is a pilot with skill that'd make you weep with envy. He's proving it, too. He makes a safe landing in front of an enemy Rifleman, shouting something as he landed. Laura is shouting too as she follows "Don't do that! Don't do that! Don't.." she makes a safe landing, far in advance of us.

Rychek's got a Condor smoking; I didn't see the hit. I miss. Again. So do the three Condors. Davidson's Vindicator and Silverton's Archer are arriving on the scene behind Sven. Sven's Archer just stands there, firing long range missiles at the oncoming heavy 'Mechs. The range was extreme, but one of them returns fire. There are bursts all around us. "*Himmel!*" I heard Rychek "Cadets! Don't fire on us, blast your eyes!"

"Dragon Three, this is Dragon Leader. Break off, this one

is mine!" Laura's Phoenix Hawk turns away from the Rifleman to fire on the advancing Warhammer. A Shadow Hawk rises in the air, advancing on Hiro's Catapult, two on one.

Rychek snaps, "It's up to you, Bird Four!"

"What?" I say stupidly. She jets up to challenge the other Shadow Hawk. I jump and fire, reflexively. Nobody could be more surprised than I am as I hit the damaged Condor square in the hover fans, and watch him spiral out of control. Davidson's PPC and lasers fire from beside me, blasting armor off one of the two remaining Condors.

Sven and Silverton run on by me to where Laura's Phoenix Hawk is holding off the Warhammer and a Crusader. She's staying mobile, not trying to fire much, just harrasing them and waiting

for help. Just as they close, the Warhammer finally passes Kimi and David in their concealed position. They fire all they have, straight into its poorly armored back. David fires once and ducks down. Kimi stands to fire a second time. This time, two of her lasers hit, but the Crusader hits her. It's one of those flukes, a perfect cockpit shot.

I hear Davidson's Vindicator fire again, PPC and both lasers. He misses with everything. I hit with my SRM four pack as the second Condor is coming in. The first Condor hits the Vindicator; some torso armor scaled away. The second Condor has taken out both my right leg jump jets. Fair trade; it's a cloud of smoke now.

Rychek hits the Shadow Hawk. It hits her. Both torso hits, no major damage. The Rifleman hits Hiro's right leg. He hits it in the left arm.

Our Archers target in on the Crusader. Kimi's 'Mech sways and falls. She seems to make no attempts to keep it upright. There's a gaping hole in the head. Sven hit with two mediums (he was too close now for the LRMs). Silverton misses, stepping in the river, sawing the air wildly with his arms, falling prone. Sven runs to draw fire away from him.

Laura scores a hit on the Warhammer with her machine guns and large laser. I think she'd aimed for the head and got the torso, but it's a hit! (She's even worse at gunnery than I am.)

Davidson's Vindicator braces itself beside me and fires everything at the remaining Condor. His LRMs hit it at the far point of its turn, and it drives straight into his PPC fire. No more Condors! He runs toward the battle. I limp after him, noticing for the first time that my left leg actuator has been damaged. Davidson is running, firing, running, firing, running...It is an

impressive display of firepower. It was also stupid. He shuts down.

Davidson is OK; the volume of his monologue makes that clear. I limp right by him. If I can just get a shot in... but the other combatants surge back and forth; the air is full of heat and smoke. I can't get a clear target.

Sven arrives to help Laura with the Warhammer. David got another brace of LRMs in, this time to its right arm. Its PPC is useless; cherry red on the sensors. Silverton pries himself up from the river bed. The Crusader fires its LRMs at the approaching Sven, hitting him in the left leg, then missing with its SRMs at David. Kimi's 'Mech lies still; I know she is gone. I see David bending over her. The Shadow Hawks continue to pound on each other; I really can't keep track of them.

Hiro takes a bad hit. His Catapult keeps half its LRM ammo in the left torso; all was unfired. The ammo explodes. The force of the explosion spreads downward and sideways. The remaining ammo in the right torso blows. There is an appalling screeching of metal, audible even over the bass rumbling that followed the explosions. Both of his legs have been blown off! I limp faster, sure that nothing I could do will get me there on time. The Rifleman takes deliberate aim at the immobile Hiro. Sven can't see him; Silverton is in the river...

Rycek's Shadow Hawk zooms past the Rifleman, firing as it comes. Her autocannon flashes along his torso without noticeable effect. The enemy Shadow Hawk follows her closely. Too closely; its medium laser fires, fusing her right arm actuator. Too closely; as it follows Rycek, its leg hits the Rifleman with all the force of its motion. The Shadow Hawk's leg crumples; it rebounds from the Rifleman and falls to the ground. Large dents appear in the Rifleman's center torso. It sways heavily, but keeps its feet.

Silverton runs toward the Catapult as Davidson moves past me. Sven is doggedly firing at the Catapult while Laura buzzes the Warhammer, firing only her machine guns, keeping her heat down while keeping him distracted. She keeps hitting, doing fleabite damage each time. He must have hit her again; armor is peeled back all along her torso now. Sven hits again, and the Catapult's right leg fell off!

Silverton turns to the Warhammer as Davidson's Vindicator fires its LRMs into it. The Warhammer lets loose, and Davidson is unlucky. He takes hits from a PPC, an SRM six-pack, and two medium lasers. His left arm is hanging; there's something wrong with his right leg; his right torso looks like swiss cheese. He has only his PPC now, and the medium laser in his head. He fires both at point blank range as Silverton's Archer lets loose with its long range missile packs. I can hear the shouting on my radio link as everything connects; the PPC burst finds a hole in the torso armor and smoke starts coming from inside. When two of the long-range missiles find the same target, the Warhammer starts to sway.

A gyro hit! The Warhammer fire everything it has left, and misses, so badly was it swaying. The pilot must be seeing everything double!

Sven, meanwhile, has picked up the Catapult's leg and was using it for a club. He was having a grand time, whooping in Swedish and banging away at it. I think something has gone wrong with its targeting computer; it can't seem to hit him as he slowly beats it to scrap.

And David hits with every long range missile he has, right into the Rifleman's barely-armored back. Some of the autocannon ammo explodes, the engine blows straight forward, halfway through the armor of the center torso front. You can hear the pilot coughing, then swearing as he tries to punch out and fails. Then, mercifully, the rest of the ammo blows. We couldn't have gotten him out. Hiro is beginning to make groggy noises from inside his legless 'Mech. He'd been knocked out and was only now coming to.

The end is messy. Neither the Warhammer nor the other Catapult will surrender. We take the Warhammer pilot alive at last; the Catapult pilot dies when his 'Mech takes a cockpit hit.

Rycek pulls me aside, keying the private channel. "I didn't want to leave you alone there, Daniel. But when I saw him take that hit! He'd been screaming about family honor, so I knew he wouldn't break off... That Rifleman was a cousin or something even closer.. But it's not necessary to mention it to anyone, OK? Well, you did all right — You even hit something. You're blooded now."

David is our field medic. He does his best for Hiro while Silverton and Davidson bury Kimi. Her Catapult is in almost perfect condition. It only lacks its soul — the pilot.

And then we wait.

It is not often that a Mechwarrior saves the life of a superior. It's more usual the other way around. Rycek has saved Hiro's life. They were enemies not long ago. It is possible they will be enemies again. What can he possibly say to her, "Thanks for the memories?"

The dialogue between them sounds like this: Rycek gives a crisp status report, motioning to Sven to do the same for the Fire Lance. She ends by deliberately asking for the impossible "Permission to salvage, Captain?"

Slowly, Hiro returns, "I regret I must refuse. The troops have earned their reward, I agree. Have them place salvage markers — but as many as are fit must continue. The relief of Jotunheim must not be delayed."

A combined lance under Rycek marches forward while Davidson and I prepare to salvage what we can. The last exchange my recorder holds is quite mundane.

"Perhaps we might share a flask of saki when I join you in Jotunheim?"

And Rycek in the most formal voice of Japanese, "*Honorable Hiro, I'll look forward to it.*"

Technical Readout

AT-1B Wildcat Aerospace Tanker

AT-1B Wildcat Class Aerospace Tanker Overview

During the July 9, 3038 broadcast of *Behind the News*, an investigative news program popular in the Lyran Commonwealth, ace aerospace pilot Clayton Andrew was asked what was the worst thing about his job. His reply was, "We (pilots) aren't afraid of dying in the course of a mission; it's dying in a ship that could get you home if it just had a little more gas. We've all had friends lost that way."

The aerospace fighter trade off: either more fuel or armor and weapons.

One solution to the problem is to provide an external source of fuel so aerospace fighters can either operate further from their base or DropShip or expend more fuel without fear of not returning to their base or DropShip. The aerospace fuel tanker is one solution to the fuel problem. All spacecraft use hydrogen for fuel. The tankage for hydrogen in a gaseous state is the principle limiting factor in most aerospace fighter design. In the past experiments were made with fuel tankers carrying gaseous hydrogen, with poor results. The ships could not carry enough hydrogen to be of any great use without being the size of DropShips themselves.

During the height of aerospace development in the old Star League, hydrogen fuel was compressed and frozen to near solid. This process increased the amount of fuel ships could carry. The process was lost during the many conflicts of the past.

Not until after the Fourth Succession War did Kalin Aerospace put the rediscovered technology for using frozen hydrogen into an aerospace craft. In a computer controlled tank, hydrogen is compressed and frozen solid. The tank only takes up a fraction of the space needed for holding standard gaseous hydrogen. This allows a fuel tanker to be no bigger than a large fighter and still carry over forty tons of hydrogen fuel.

The AT-1B Wildcat Class Aerospace Tanker is the first production fuel tanker to employ this rediscovered technology. The Wildcat is the first aerospace craft to be produced

by Kalin Aerospace as the prime contractor in over two hundred years. A spokesperson at Kalin Aerospace said that much of the rediscovered technology had its original research done by the New Avalon Institute of Science and Technology. The AT-1B is just one of many new aviation products that the company plans to introduce. (For more information on Kalin Aerospace, past and present, see the June 3039 issue of *Aerospace Today*.)

Capabilities

The AT-1B Wildcat's main mission is to provide fuel for aerospace fighters in space. The Wildcat has medium armor coverage and two medium lasers for defense. It should always be deployed with other combat units in combat situations; it isn't designed to be a front line unit.

The Wildcat has a crew of two, a Pilot and a Mission Specialist/Co-Pilot. The Wildcat can carry forty-five tons of frozen hydrogen fuel. The computerized tanks reheat the fuel to a gaseous state for transfer and use by the tanker. Five tons is normally retained for the tanker's engine. It can refuel two aerospace fighters at a time from its service refueling arms. The two service arms can extend ten meters. Aerospace fighters can be refueled either in space or on the surface of a world, but not while flying in an atmosphere (the service arms are not aerodynamic). (Complete rules for refueling can be found in the AeroTech and BattleTech Manual under 'Fighter Refueling'.)

In normal in-space refueling, the tanker will match speed and course with the receiving aerospace fighter. The Mission Specialist will deploy the service refueling arm and attach it to the aerospace fighter's fuel port.

Battle History

The AT-1B Wildcat is being produced at an undisclosed location at a rate of forty-plus a year. Over sixty have been delivered to various governments. As it is a new aerospace vehicle, the Wildcat has seen little true combat, but Pilot and Ground Crew training are on schedule. House Steiner is the

first government to receive the Wildcat. Reports from their pilots indicate that the Wildcat performs up to and beyond its design standards.

The Wildcat has two basic missions: Mission A — Long-Range Fighter Sweep, and Mission B — High Speed Transport.

Mission A: this mission has proven the Wildcat to be a valuable addition to Aerospace Fighter Lances. A DropShip will launch the fighters and tanker at a greater than normal distance from its target. This allows the DropShip either to wait out of harm's way or to go on to other duties. The fighters can use more fuel and so have greater speed to their target. At a point before they reach their target, the tanker will refuel all of the fighters. The tanker will then withdraw a safe distance from the combat zone, either to wait until the fighters withdraw so as to refuel them for the return to the DropShip, or to land at the objective once they have secured it.

Mission B: The Wildcat has the largest fuel supply of any aerospace vehicle. It can use its large fuel supply to make a one-way high speed trip between two points eight times faster than any other aerospace fighter. It can make a round trip four times as fast. It will still have four to five tons of fuel left when it reaches its destination.

Typical transport arrangements are:

- 1) 2 crew and 100 kg of cargo
- 2) 1 crew, 1 passenger and 100 kg of cargo
- 3) 1 crew and 400 kg of cargo

Variants

Four AT-1As were produced as working prototypes. They only have 1/2 the fuel capacity of the production AT-1B. At the time of this writing, Kalin Aerospace is using them to experiment with other possible designs and systems.

It's rumored that House Steiner has removed all weapons from several of its AT-1Bs to increase the cargo carrying capacity up to two tons. They changed the name to the AT-1C Cargo Cat. Kalin Aerospace takes no responsibility for and has no input with the development of this variant. It must be noted that the weapon mounts and wiring are designed for easy removal and installation of different weapon systems. Many unofficial variants should be expected.

Note 1: The Service Refueling Arms are housed one in each wing. When all the armor is gone from a wing, the Arm stored there is destroyed.

Note 2: Neither the new hydrogen fuel technology nor the physical size of an aerospace fighter affect the playing of the BattleTech simulator game.

AT-1B Wildcat Class Aerospace Tanker

Mass: 100 tons
 Frame: AT-1 series
 Engine: Collins 300 Aero
 Armament: 2 Martell Type 4
 Medium Lasers
 Main Manufacture: Kalin Aerospace
 Communications System: RCA CommLink 55
 Targeting /
 Tracking System: RCA TrackLink 65

Simulator Stats:		
Type:		Tons:
AT-1B Wildcat Tanker		
Tonnage:100 tons		100
Thrust: 5		
Overthrust: 7		
Structural Integrity:		10
Engine 300		38
Fuel: 675 points		45
Cockpit:		3
Heat Sinks: 10		0
Service Refueling Arms:2		1+1
Weapons:		2
Type: Location		
Medium Laser Nose		1
Medium Laser Rear		1
Armor: 160 + 10		10
Armor Factor:		
Cockpit: 10 + 5		
Nose: 40		
Wings: 20 / 20		
Fuselage: 45		
Engine: 30		

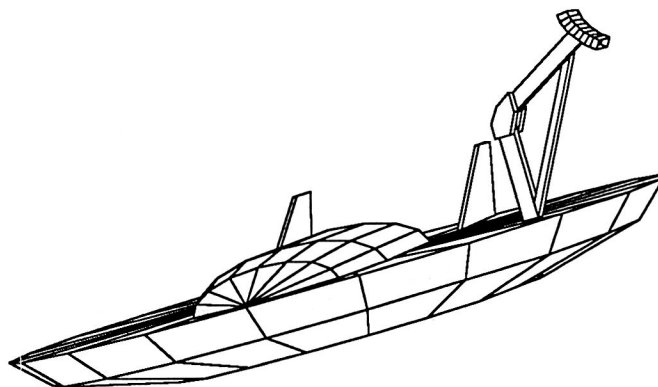

AT-1B WILDCAT AEROSPACE TANKER

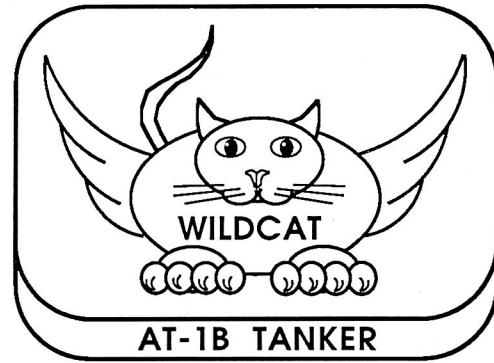

THE WILDCAT INSIGNIA

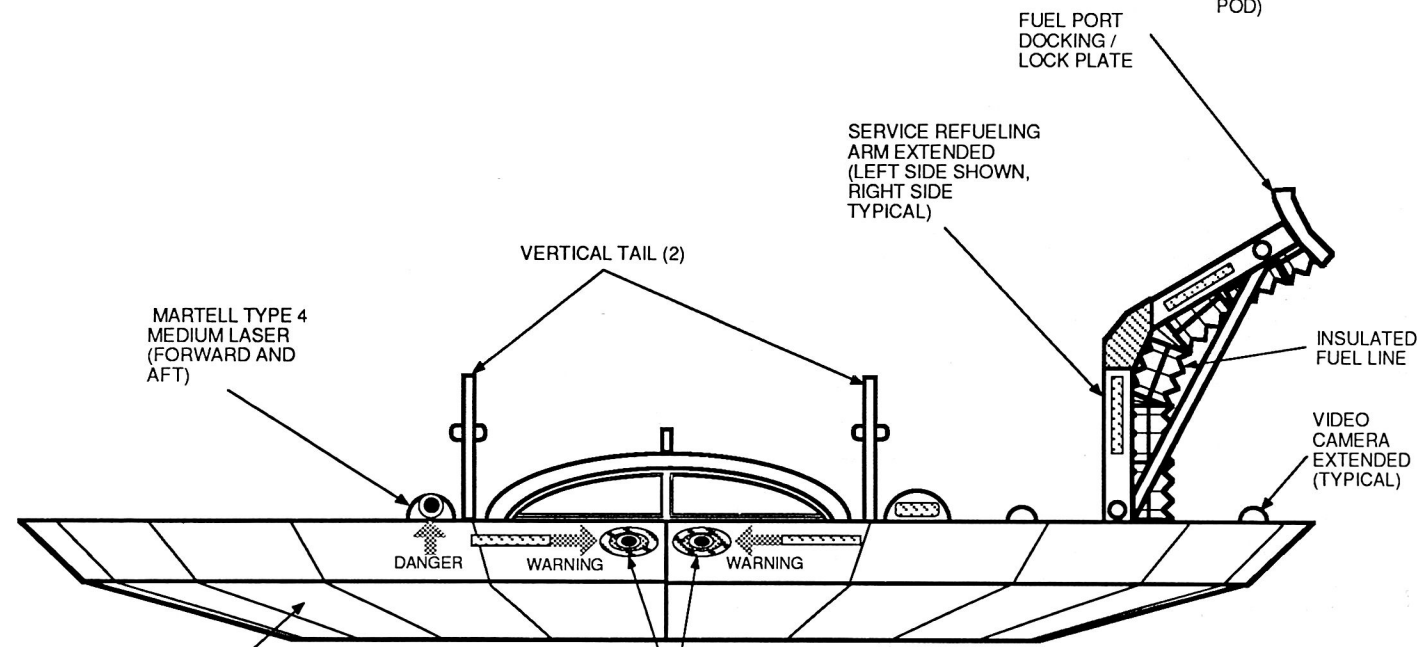
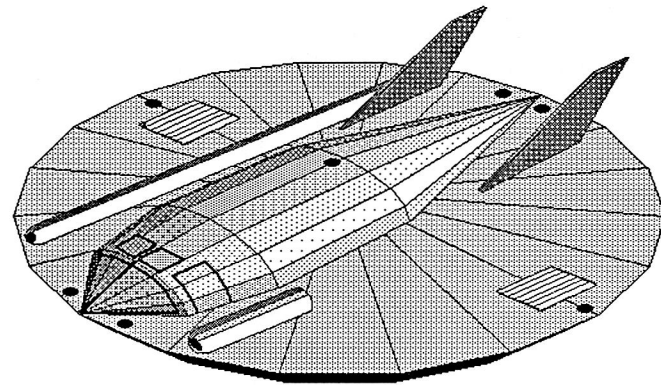

LOOKING AFT
(FRONT VIEW)

LOOKING DOWN
(TOP VIEW)

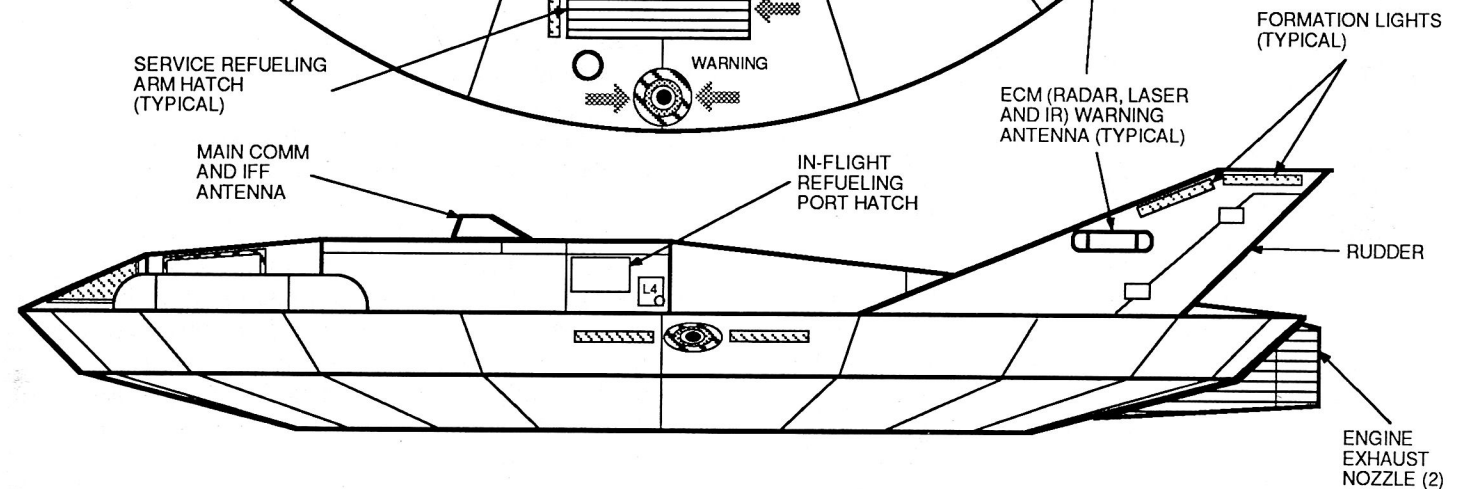
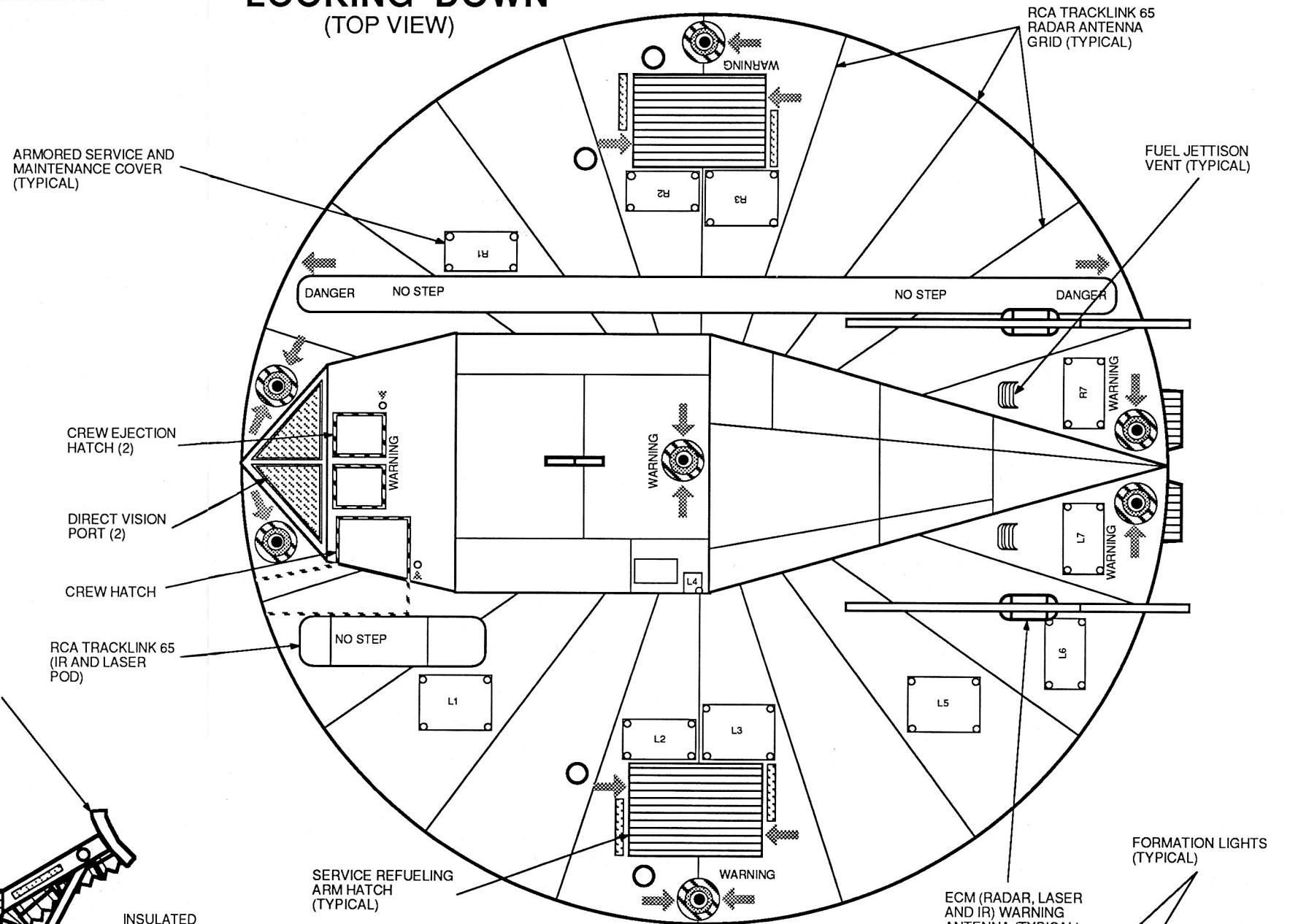

LEFT SIDE
(RIGHT SIDE TYPICAL)



AWAY BOARDERS !!

by Harrison Coulter

JumpShips are perhaps the most valuable pieces of equipment currently being used throughout the Inner Sphere. Without JumpShips, interstellar travel would be all but impossible and civilization as we know it would fall into chaos and ruin. Because they are rare, expensive to maintain, and difficult to construct (even using salvaged parts), JumpShips are the only vessels which are virtually immune to attack.

How, then, does a mercenary company, trading cartel, or Successor State obtain these scarce and valuable vessels? Outright purchase is the most obvious and the most honest method of acquiring JumpShips, but since even the smallest of JumpShips have prices which range into millions of C-bills (3,000,000 Cbs for a new Scout class JumpShip), none but the largest mercenary outfits and merchant companies can afford to buy a JumpShip, even if one could be found for sale. Since JumpShips are by custom protected from attack, salvaged vessels of this type are uncommon, to say the least. The only remaining viable way of obtaining a JumpShip is to capture one.

The capture of a JumpShip is one of the knottier tactical exercises that an infantry unit can face. Approaching a JumpShip parked in-system is only the first of several problems. If the boarding party waits too long after the ship arrives in-system, the crew may have enough time to recharge the ship's Kearny-Fuchida drives, and jump out-system. If the assault is made too soon, the prize crew will have to sit and wait while the K-F drives recharge, and run the risk of the vessel being retaken.

The most common method used by the latter-day pirates who wish to capture a JumpShip is to impersonate the DropShips which are scheduled to dock with the JumpShip. These

impostors are used to carry the boarding parties to their prey. Another common tactic has the DropShip on station at the nadir or zenith points of the star's gravity well. Posing as customs or security officials, or even employing a false distress signal, the boarders are generally able to gain entrance to the JumpShip. Quite often, they obtain complete surprise over the JumpShip's crew. This tactic generally works best with a JumpShip on a scheduled run, as the DropShip need not remain on station for days or weeks, waiting for its victim to appear. The JumpShip's own DropShips could even be seized while on the ground, and then used to approach and board their parent craft. This particular method works very well if some member of the DropShip's bridge crew can be convinced to stay aboard and help with the approach.

It should be noted that stealing of JumpShips which are on scheduled runs tends to make ship owners and captains a little hesitant to make pick-ups or deliveries in systems where previous attacks have taken place.

Once the boarders have reached the JumpShip, the problems multiply. Due to the rarity and the fragile nature of some of the systems and components aboard a JumpShip, mass damage weapons like SRM's, grenade launchers, man-pack lasers, PPC's, and flamers are generally shunned for boarding operations. The fact that JumpShips are in free-fall (that is, they lack artificial gravity) precludes the use of high- or sustained-recoil weapons like assault rifles, shotguns, or SMG's. Free-fall also makes it difficult to use melee weapons like swords, cudgels, and the like, since the body's weight will no longer counterbalance the force of the swing. Even the impact of a projectile weapon can send the person struck into an uncontrolled spin. Very few weapons are suitable to zero-G combat. Obviously, energy weapons such as lasers and stunners have little recoil. Recoil will send the one who fires it caroming around the null-gravity of a JumpShip's interior like a billiard ball. Gyrojet and tranq weapons have very low levels of recoil energy to impart to their user. Likewise, crossbows and longbows have almost no recoil and are frequently used by both boarders and defenders.

Boarding parties are as a rule specially trained for the express purpose of capturing JumpShips. Much like the special anti-terrorist squads of the five Successor States, these boarding parties should be familiar with the internal layout of the JumpShips which they plan to capture. If possible, diagrams of the ship's corridors, docking bays, living spaces, and so on would be studied by the boarders before the operation begins. The boarders should memorize the shortest routes from the docking bays to the bridge, engineering section, and the crew's quarters. When available, LCD memo pads similar to those worn by aerospace pilots can be used by team leaders to aid them in finding their

way through the veritable maze of accessways and corridors which make up a JumpShip's interior.

When attempting to capture a JumpShip, three of the primary objectives for the attacking party are the engineering section, the crew's quarters, and the bridge. By capturing these three vital areas, the boarding party can effectively paralyze all other sections of the ship.

Capturing the engineering section of a JumpShip enables the boarders to take control of the drive and life-support systems throughout the entire ship. Once the drive room has been taken, the remainder of the ship can be captured at the boarders' leisure, as the attackers need not fear losing the ship to an out-system jump. If need be, the boarding party can even override the bridge jump control circuits, and take the ship outsystem themselves to a place where the beleaguered ship is less likely to receive assistance from friendly forces.

Capturing the life-support areas of the engineering section lets the boarding party literally extort the vessel from its crew. Such an incident occurred when Helmar Valasek's pirates attempted to seize the *Hapsburg Maiden*, a merchant-class JumpShip registered to ExoStar Industries out of Luthien. The attack took place in the Susquehanna System of the Draconis Combine. Two weeks later, the Maiden was found drifting derelict near the Holmsby System. A combine security team boarded the ship, only to find that everyone aboard was dead of vacuum exposure. It seems that both the crew and the pirates alike were killed when the bandits attempted to decompress the area of the ship occupied by its crew. Apparently, the pirate Tech working at the ship's master life support control panel was not very competent. Rather than bleeding off atmosphere slowly, he released the pressure all at once, opening the ship to space. Under ordinary circumstances, the airtight bulkheads which divide the ship into several different compartments would have limited the areas decompressed to those which were open to space. However, during the fighting, several doors and bulkheads had been breached. As a result, all areas of the ship suffered a catastrophic decompression. Only the ship's automatic log remained to tell the tale. The ship's drives had already been programmed for their next two jumps. Therefore, with no one aboard to reprogram the drives, the ship made its jumps and ended up in the Holmsby System, the next scheduled stop. For a time, the *Hapsburg Maiden* was sensationalized across the Inner Sphere as a 31st Century "Flying Dutchman".

Capturing the crew's quarters limits the number of effective fighters that can be mustered against the boarders. Since they generally lie a long distance from the docking bays, it is difficult to secure these areas by force. Here, guile serves the pirates best.

A few men posing as crewmen, or, if possible, a few actual crew members who have been suborned by the pirates, can produce weapons and secure the living spaces,

preferably just as the pirates are docking with the JumpShip. Often only a few men are needed to accomplish this task. On the average, 4 to 6 men are enough to perform this mission. The number of men depends on the size of the JumpShip's crew.

Men who are already members of the crew who have been bribed by the pirates are the best for this job. This is because newcomers are usually treated with suspicion by the existing crewmembers — who tend to be somewhat clannish.

In one case, three crewmembers of the Monolith-class JumpShip *EJ Mallory* set off gas grenades in the crew's quarters, rendering about one third of the ship's complement, themselves included, unconscious. The traitors were found out when the pirates who hired them failed to take the ship and were captured. One of the pirates confessed to charges of piracy and attempted theft of a JumpShip. In his confession, he named the three suborned crewmen.

The bridge is the nerve center of any vessel. By capturing it, the boarding party is able to gain control of most systems and sections. Communications, navigation, and command centers are only a few of the vital areas housed in the bridge. The bridge should be taken as quickly as possible, or the bridge crew might have enough time to send off a call for help, jump the ship away from the bandit's ships, or even wreck the bridge controls, rendering the ship inoperative.

A JumpShip's interior creates a tactical nightmare in which ordinary small group tactics are useless. Narrow corridors, small rooms, and lack of gravity all combine to make for conditions guaranteed to confuse and disorient even the brightest infantry tacticians. For this reason, special tactics and equipment have been developed for combat aboard JumpShips.

Low-recoil, fully automatic weapons, like a cone rifle, are preferred. With them, the long narrow corridors can be used as fire lanes, to prevent reinforcement of enemy position. Rooms can be cleared of enemy troops one at a time by firing in an irregular burst-pause-burst pattern and by coordinating the pauses with the movement of an assault group. In ideal circumstances, the cone rifle should be supported by a marksman armed with a laser rifle. He can suppress enemy fire while the assault team is moving, with less danger of hitting his own men than the gyrojet gunner.

As rooms are cleared, the assault group can provide covering fire for the cone rifle team, while that team moves into a better position. Once the fire-suppression team sets up in their new position, the whole process can begin all over again.

Clearing a room aboard a JumpShip is a nasty business. Often attacks are made at close range with melee weapons. Quarter is rarely asked and seldom given.

Smoke, gas, or stun grenades should be thrown into the room as the assault group approaches it. As soon as the

grenades go off, the assault team should quickly enter and secure the room. Each team member should know his job and be able to perform it without hesitation. If a man pauses to think, it could cost not only his own life but also those of his teammates.

If possible, the room should be attacked through a number of doors all at the same time, catching those inside in a crossfire and limiting or eliminating the occupants' escape routes.

During an operation of this type, it is usually impossible to guard prisoners and unwise to leave a merely unconscious man behind. Therefore, in order to avoid any unnecessary killing, provisions should be made for restraining any of the enemy who survive the fighting. Given the brutal nature of this type of combat, disposing of prisoners is more often than not a moot point.

The process of clearing rooms and corridor resembles city fighting on a much smaller scale. The assault group should carry a variety of melee and fire-combat weapons. A traditional weapon used by both sides of a boarding action is the cutlass. The cutlass, whose roots go back to the 17th century on earth, is a shorter, heavier version of the standard sword, with a single, slightly curved cutting edge. (The average cutlass is 80 cm long and weighs about 2 kilos.) In spite of its small size, the cutlass is still a horrendously effective weapon, capable of completely severing an unarmored man's arm with a single blow. Most men fighting on shipboard carry a knife or dagger for close combat. Occasionally, other types of melee weapons are carried in boarding parties. Long spears with an auxiliary hooked blade called boarding pikes are exceptionally useful. In addition to their use as weapons, boarding pikes are exceptionally useful when employed as grappling devices by means of the hooked blade (or fluke). Clubs, stun stick, vibroblades, and even the occasional neural whip have found their way into the hands of boarding parties. Regardless of what type of melee weapon is chosen, remember that in a zero-G environment such as is found aboard a JumpShip, any blow can send an unanchored man into an uncontrolled spin.

For fire combat, most assault group members carry a pistol, with laser and stunner varieties being the most obvious, by reason of their lack of recoil. Slug and tranq pistols, along with submachine guns, are more likely to be used by boarders and defenders alike, because they are less expensive and easier to obtain than energy weapons.

When using a projectile weapon, it is important to brace oneself against a wall, door frame, structural member, or other solidly attached object. This minimizes the effects of firing a non-recoilless weapon in a gravity-less environment. Gyrojet rifles do not completely eliminate the problems of recoil-imparted spin, but the low/high pressure firing system used in a cone rifle's projectiles goes a long way toward

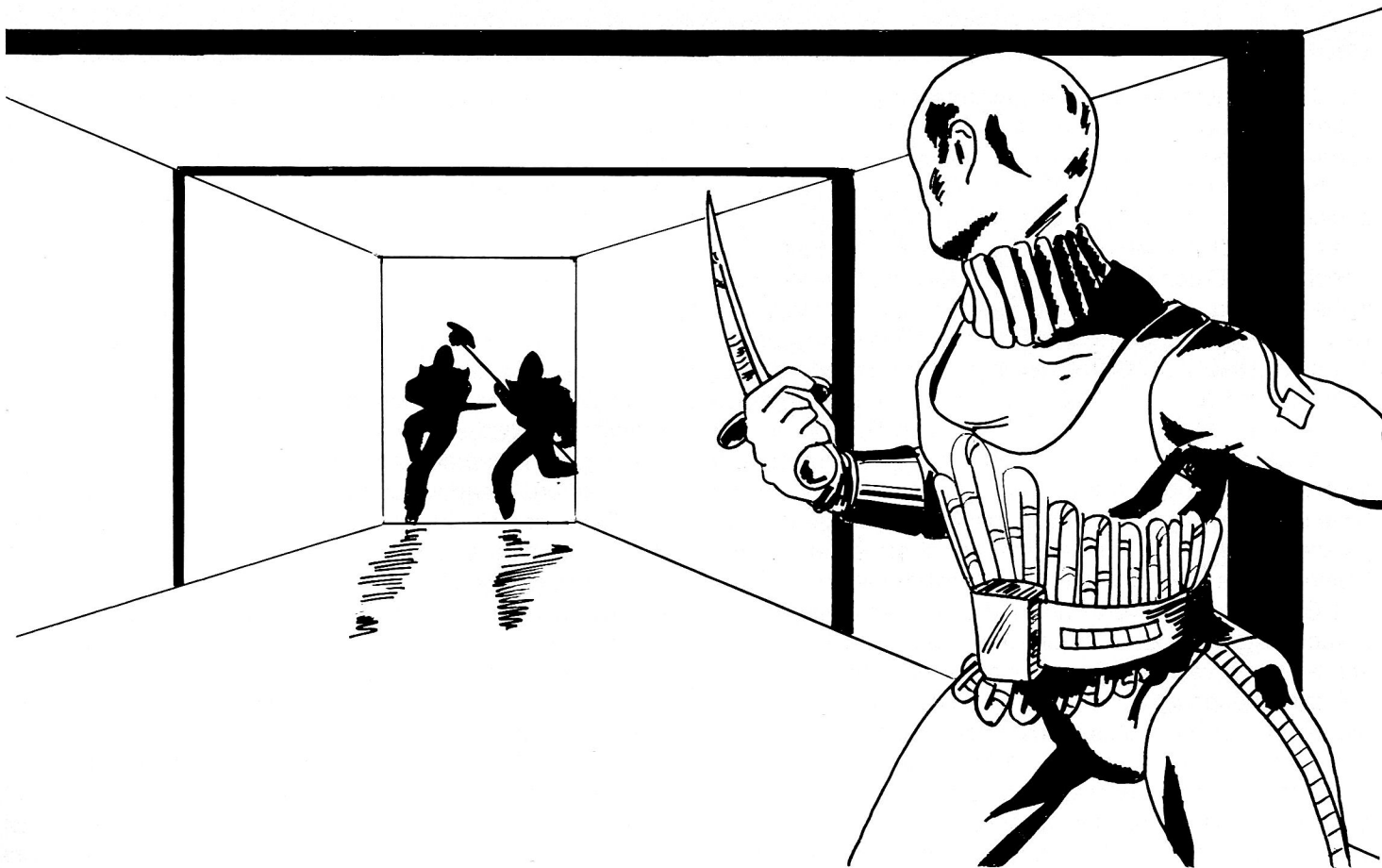

reducing it. Even the normally recoilless crossbow and long-bow can impart some degree of spin to their user in a zero-G situation. As the limbs of the bow snap forward, propelling the arrow, they cause a slight recoil. The only difference between the recoil of a bow/crossbow and the recoil of a firearm is that the firearm drives its user's upper bod backwards, while the snap of the bow causes a slight pull forward. Under ordinary circumstances, this minute amount of recoil is hardly felt. In freefall, however, any amount of force, no matter how small, has an effect on a weightless body.

Over the years there have been many devices invented for counteracting the effects of freefall. These gadgets cover the entire spectrum from the ingenious to the bizarre. One device, invented in the early 21st century, falls into the latter category. Consisting of a pair of specially designed boots whose soles were made up of a series of sucker clamps, this gadget was purported to permit a man in a zero-G environment to stand in one place while operating heavy equipment. These clamps were affixed to a smooth surface, like a deck or bulkhead, by placing the sole of the boot against the surface and pressing down with the foot. Lifting the foot released the clamps. Suction was provided by means of a small pump located in the thick sole of the boot. Pressure forced air out of the sucker clamp. Releasing pressure

permitted air to flow back into the clamp, freeing it from whatever surface it was attached to. The theory sounds plausible. The device failed miserably whenever it was used.

The most efficient piece of hardware for dealing with the effects of weightlessness is a small, lightweight version of the infantry jump pack. Called the Personal Maneuvering Unit, or PMU, this backpack-like device weighs a little over 3 kilograms and operates in the same manner as a regular jump pack. Controlled "flight" is accomplished by a series of steerable nozzles set in the PMU's casing. The unit's controls consist of a pair of joysticks which extend forward from the backpack at waist level, one on either side of the body. The Personal Maneuvering Unit has its roots in the 20th Century space program. It was developed for use by stevedores and shipyard personnel aboard deep space freighters during the 22nd Century.

It should be noted that PMUs are only used in short spurts, to control the direct and velocity of a man's "flight" in a zero-G environment. Used in this fashion, a PMU will have a fuel supply of about 3 hours. If used constantly, its propellant will be exhausted in a few minutes. This limitation makes PMU's unsuitable for infantry jump packs. They will not generate enough thrust during their limited burn time to lift a man off the ground. PMU's are not intended to counteract the

recoil of a projectile weapon. They merely permit one who is suffering a recoil-imparted spin to regain his equilibrium a bit sooner than one who is not so equipped.

In any combat situation, body armor is an important consideration. Armor worn in zero-G combat often incorporates many of the same systems used in a vacuum suit. Special zero-G combat armor is constructed of ballistic cloth in the form of a jumpsuit with attached boots and gloves. The visored helmet attaches to the shoulders of the suit by means of a locking ring. Zero-G armor does not carry its own heating/cooling system like a vacuum suit. It only carries a small reserve tank of air. If a man wearing zero-G armor is in a section of the ship which suddenly loses its atmosphere (assuming he survives the initial decompression), he will have just a few minutes to make his way out of the decompressed area. Since a small amount of air is carried, the helmet visor is kept open until it needs to be closed to seal the suit. Obviously, damage to the suit will threaten its integrity as a vacuum suit. Most suits of zero-G armor incorporate a short-range personal communicator, a PMU, and attachment points for weapons, powerpacks, etc. Some more advanced models include flashlights, suit recorders, and even IR detection gear.

In most cases, the crew of a JumpShip has the rather annoying habit of refusing to simply hand their precious vessel over to the boarding party. For defending crewmembers or for boarding parties who have recently captured a JumpShip and who don't wish to surrender it, we offer the following thoughts:

The simplest way to protect a JumpShip from being seized by boarding parties is not to be there when they attack. As soon as a JumpShip arrives in-system, the crew should waste no time in rigging out the "sail" and beginning to recharge the Kearny-Fuchida drive system. When transferring cargo or taking on supplies, the ship's own DropShips would be used if possible. Special specific codes and prearranged signals should be used as standard operating procedure during communications between the DropShips and JumpShips prior to the docking procedure. That way, the crew of the JumpShip can learn well in advance whether or not everything is as it should be aboard the DropShip. Codes for both normal and emergency systems will give the JumpShip crew valuable time to react appropriately.

If warning that a DropShip full of hostiles is approaching can be given, the defending crew can initiate a preplanned sequence of events in order to repel the boarders.

First, if at all feasible, the JumpShip should furl its sail and jump outsystem as quickly as possible. When the incoming DropShip is one of the jump vessel's own, this option is unpopular. Especially considering the price of DropShips, and the lives of their crew.

If it is impossible or unethical to simply abandon the

DropShip, the JumpShip's crew must prepare to fight. The first line of defense should be the docking bay. One school of thought states that the defenders should attempt to use the access way between the DropShip and the JumpShip's cargo/docking bay to limit the number of attackers the defenders will have to face. Other tacticians say that the roomy docking bay provides the defenders with enough space to establish overlapping zones of fire originating from places within the bay and from access ways leading into the bay. Since most docking bays have thick, reinforced bulkheads (which guard against damage to the ship if a DropShip collides with the JumpShip during docking maneuvers), the docking bay is perhaps the only place in the entire ship where high-damage weapons could be used.

Given good luck and prior planning, the defenders may not only be able to save the JumpShip by making a stand at the docking bay, they may also be able to capture the enemy's DropShip. In more than one case, the attackers have been put on the defensive when the JumpShip crew made a fast assault through the open docking port into the hostile DropShip. This is, however, a touchy tactical problem. It is best left up to seasoned crews.

If the docking bay defense fails to repel the boarders, the crew should fall back in an orderly fashion to the next defensible position. An orderly withdrawal while under fire is a difficult procedure at best, even when accomplished by a series of leapfrog fire-and-move jumps. This operation resembles the procedure for clearing rooms already detailed, only in reverse.

Often an intersection or bend in a passageway provides the next best defensible position. At an intersection, the branching corridors provide lanes of fire for a ready-made crossfire. A blind turn in a passageway means that anyone coming around the corner will expose himself to fire from guns which have been all but bore-sighted on the angle.

As discussed above, the bridge and engineering sections of a JumpShip are the most vital areas of the vessel. They should be the *last* lines of defense. Most of the fighting in such places will be hand-to-hand, or will be conducted using low-power weapons like stunners and dart pistols, since neither side will be especially willing to damage or destroy the valuable and rare systems located there.

One classic example of JumpShip boarding operation is the case of the *Raidan*, an Invader class JumpShip which was seized in October 3024. On October 21, 3024, the *Raidan* was making a scheduled stop at Elgin in the Tikinov Commonality of the Capellan Confederation (now part of the Sarna March of the Federated Commonwealth). As the ship lay on station at the zenith point of the system's sun, she detached a Leopard class DropShip to make a delivery of machine parts to the planet. The *Raidan* rigged out her collector and began to recharge her K-F drives while awaiting

the DropShip's return.

Unknown to the *Raidan's* crew, select members of the mercenary company Le Mat's Maulers had seized the DropShip. They returned it filled nearly to overflowing with the better part of an infantry company.

As soon as the docking bay crew had opened the locks between the two vessels, Le Mat's troops swarmed into the JumpShip. Having had no warning that their vessel was in danger, the crew took almost five minutes to react. By then it was too late. The boarders deployed rapidly throughout the vessel, capturing the engineering section and most of the crew's quarters before the startled crew could make a defense. After several short firefights in the corridors, the boarders took control of the bridge in a bloody melee. The operation took twenty-seven minutes from start to finish. Out of eighty-four mercenaries, twenty-one were killed or seriously wounded. Among the dead was Captain Gaston Le Mat himself. Forty-eight of the seventy-five crewmen aboard the *Raidan* became casualties of the attack. The remaining twenty-seven crew members were released unharmed, except for injuries sustained during the battle, on the Marik world of Augustine, where the balance of Le Mat's Maulers was encamped with the company's 'Mechs, waiting for the spaceborne pirates to return.

Le Mat's seizure of the *Raidan* is an excellent example of the way boarding operations are supposed to work. The mercenaries were divided into several teams, each with a specific task to accomplish. Once the operation was underway, each team secured its area as quickly as possible.

Obviously, not all operations will go as smoothly as the capture of the *Raidan*, but with careful planning, proper training, and a substantial amount of good luck, a well-organized good luck, a well-organized boarding party should be able to capture that most valuable of all space vessels, a JumpShip.

Harrison Coulter is a correspondent and investigative reporter currently working out of the New Avalon offices of BattleTechnology. Prior to becoming a journalist, he served six years with the New Syrtis Fusiliers, 3rd Infantry Support Battalion. The last two of those years, Coulter was a gunner aboard a Maxim Heavy Hover Transport Vehicle.



DISCLAIMER

It is neither the policy of BattleTechnology nor the personal habit of correspondent Harrison Coulter to condone or advocate the theft of property or piracy of space vessels. The foregoing article is presented merely as an overview of the problems faced by combatants in a zero-G environment

The Following are modifications and additions to the standard MechWarrior combat simulation system for tactical recreations of zero-G shipboard combat.

Skills: Zero-G Combat (Dex/Lng) This skill reflects the degree of training which the character has received in fighting with handheld melee weapons and fire combat weapons in a zero-G environment. This skill does not impart any special 'to-hit' modifiers with any weapon, but for every level of skill, a modifier of -1 may be applied to a saving roll against going into a spin as a result of combat. It also will allow a similar modifier when using zero-G combat armor or a Personal Maneuvering Unit.

Combat: The use of projectile and melee weapons while in freefall presents a major difficulty to the men fighting under those conditions. Any force on a body in freefall will cause that body to spin. The recoil of a firearm or the force of a blow with a handheld weapon can send a man caroming off like a billiard ball.

Any time an attack is made with a hand-held or projectile weapon in zero-G, the character using it must make a saving roll against the average of his dexterity and his learning scores, modified as per Table 1 below to right.

If a character fails his saving roll, he is sent into an uncontrollable spin in a random directions. (Roll 1d6 for direction.) This spin will carry the character in the direction of the spin until he collides with something. The speed of the spin depends on the type of weapon used. Any hand weapon makes the character move at one hex per turn as will a bow or crossbow. A projectile weapon gives the character a speed of 2 hexes per turn.

Should the spinning character collide with a moveable object or another character at one hex per turn, the spinning character will stop. If the spinning character's speed at the time of the collision is two hexes or more, the object or character struck will also begin to spin in a random direction. Both the spinning character and the object or character struck will now be moving at one half the spinning character's speed at the time of the collision (rounding down). Should the spinning character collide with an immovable object, he will stop, taking one hit point of damage for every hex of speed he was traveling at at the time. A spinning character may not make and sort of attack while moving.

Movement: A character in freefall may move in two ways: by crawling along a solid surface at one half his normal movement rate, or by pushing off from a solid object and 'flying' at a movement rate equal to one half his Body attribute score. A 'flying' character may move only in a straight line.

If a 'flying' character fires a projectile weapon, he automatically goes into a spin at two hexes per turn faster than his

'flying' speed.

A Personal Maneuvering Unit will permit a 'flying' character to alter his course by one sixty-degree increment each turn. This device will also permit a spinning character to arrest his movement at the *end* of the next movement phase.

Equipment:

Personal Maneuvering Unit: (2/U) The PMU is a smaller version of the standard infantry jump pack, and is intended strictly for use in zero-G. A PMU will permit a character to maneuver in freefall and move at a speed of 25 meters per turn.

Weight: 3 kilos Cost: 10,500 C-bills

Zero-G Armor: (2/R) Zero-G armor is an air-tight, one-piece suit of ballistic cloth with an attached helmet. The body suit has a protection value of 30 points. The helmet has a value of 20 points. Also incorporated into the armor is an emergency air pack (which will provide 5 minutes of breathable air), a short-range communicator, and a PMU.

Weight: 7 kilos Cost: 25,000 C-bills

Table 1: Zero-G Spin Modifiers

Weapon	Die Roll Modifier
Club/Stun Stick	+2
Dagger / Vibroknife	+1
Knife / Bayonet (not fixed)	+1
Sword / Vibroblade / Neural Whip	+3
Fixed Bayonet / Spear	+2
Tranq Pistol / Dart Gun	+1
Rfile / SMG / Needler Rifle	+3
Auto Pistol / Heavy Gyrojet Rifle	+3
Pistol / Needler Pistol	+2
Gyrojet Rifle / Gyrojet Carbine	+1
Shotgun (any)	+5
Grenade Launcher (any)	+5
Flamer	+1
SRM Launcher /Heavy Rifle	+4
Portable Machine Gun	+4
Longbow / Crossbow	0
Each level of zero-G combat skill	-1
Bracing against a wall, etc	-1
Full automatic fire	+3

Rasalhague: a Glance at independence

by Johann Sorenson

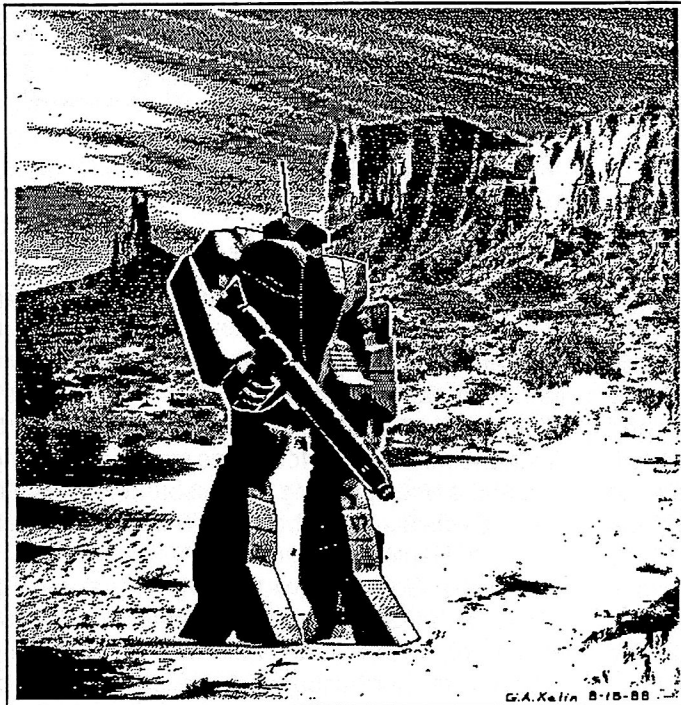

Minnesota Tribe Raider prepares to fire

History is the only way we have to predict what is to come. It is not only the Successor Houses which have rich and varied histories. With the resurgence of independent states following the Fourth Succession War, it would be good to look at their lesser-known histories and perhaps learn from them how to deal with the events we will be living through. As the ancient Greek historian Thucydides said, "Events which happened in the past will, at some time or another, and in much the same ways, be repeated in the future." The specific state we shall look at here is the newly created Free Rasalhague Republic.

Rasalhague's history begins way back in the twenty-first century when the Scandinavian countries helped the Soviets after the second Soviet Civil War. The debt was paid off; by 2238 the Scandinavians were free of any debts to the Terran Alliance. And so many of the Scandinavians emigrated over the next sixty years. They colonized Rasalhague and several nearby worlds, and when they began production facilities on these planets, they used methods which were non-harmful to the environment. Finally in 2399 these worlds banded together and called themselves the Principality of Rasalhague.

The next thirty-one years were pretty much uneventful as the Principality continued to slowly take in more worlds. Unfortunately, the other houses of this time were also expanding. In 2330, Coordinator Shiro Kurita of the Draconis Combine declared war on the Principality. His warlord Urizen Kurita utilized his famous technique of random assimilation, planet hopping and conquering in a random sequence. The confused armed forces of the Principality offered only token resistance. During this campaign against the Rasalhaguians, many of the great artists and scientific personnel fled to the Periphery. For four years Urizen's successful tactic was continued, until the New Bergen incident.

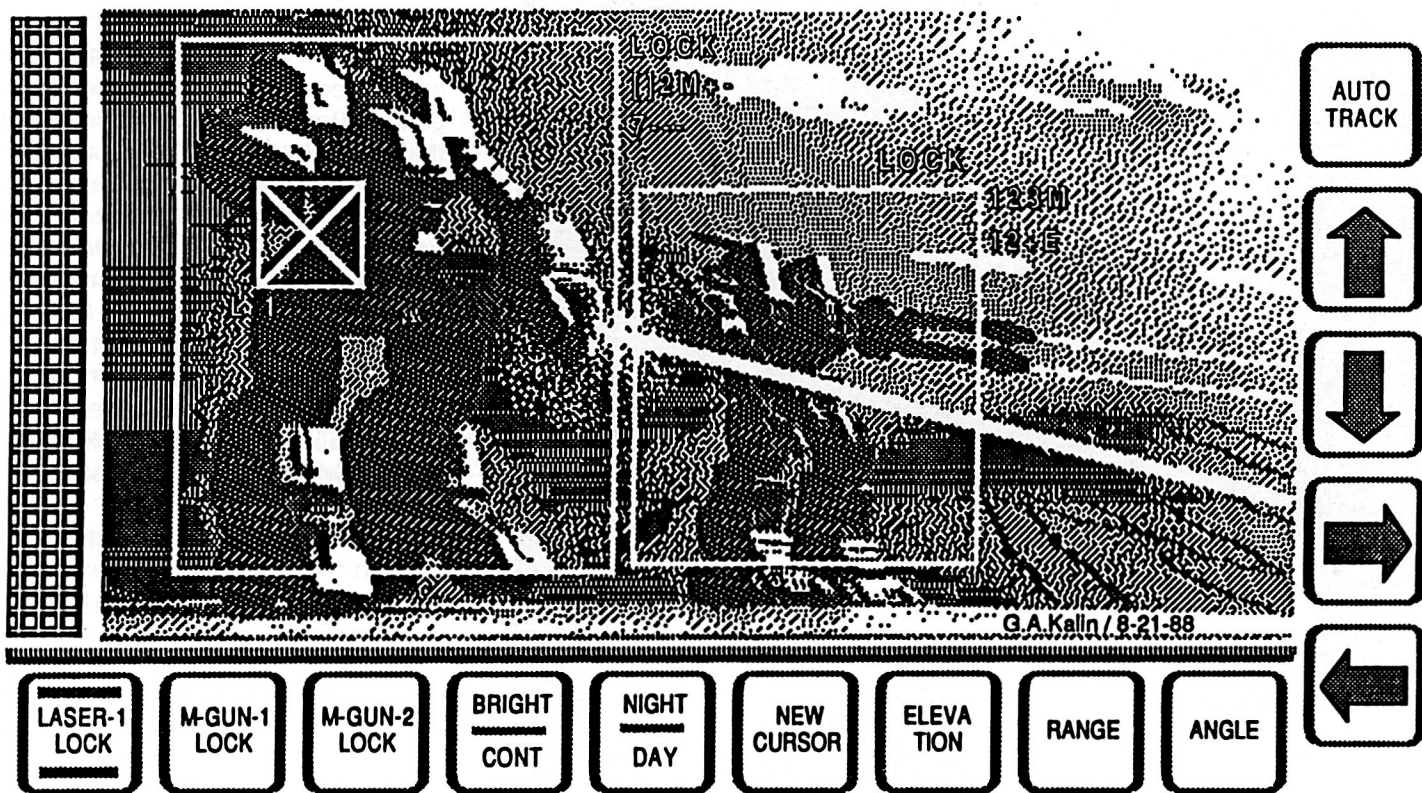

Late in the year of 2333, the warlord seized the planet of New Bergen, after successfully convincing onlookers that his next target would be Rasalhague. A defense force was sent from Rasalhague. In January of 2334 the defense force arrived. With the aid of local uprisings, it was able to destroy the Draconis Combine garrison, acquiring weapons and equipment necessary to Rasalhague's very survival, including a flight of orbiting JumpShips. With the supplies the Rasalhaguians had captured they were able to keep up the guerilla warfare until 2367, when the new Coordinator of the Draconis Combine, Tenno Kurita, declared that the Principality of Rasalhague had been vanquished. The Principality stayed officially neutral and independent until 2510, part and not part of House Kurita.

The Rasalhaguians have always had problems dealing with these Draconian invaders, yet some interesting flukes of history have linked the two states closely. A perfect example of this is the events from 2375 to 2410. On December 12, 2375, a terrorist group raided a Draconis Combine Rasalhague Military District housing complex on Rasalhague. The RMD governor, Vladimir Kurita, and almost every one of his family were killed. The exceptions were his son Jason, who

February, 2475: First 'Mech to'Mech Battle

was offplanet attending military academy, and his daughter Oma, whose body had not been found. Two years later Combine intelligence located Oma Kurita on the world of Trondheim. A rescue force was sent to recover her. They did, but at the price of killing her husband, the father of her child — who was also her abductor. This man was Jan Sorenson, father of Daniel Sorenson.

Daniel Sorenson was brought up at the Rasalhaguian Governor's Court by his mother Oma. In 2394 his mother died of chronic liver failure, attributed to the alcoholism which began after her husband was killed. After her death Daniel decided to join the military and see the universe. The new Governor was purely and simply a tyrant who had been physically and psychologically torturing and destroying the morale of the Rasalhague peoples. Daniel Sorenson decided to commit treason against the RMD governor, his uncle Jason Kurita. The rebellion grew and gained popular support. This attracted the attention of the Coordinator, who removed Jason from office. Jason Kurita in anger attempted to kill

Daniel Sorenson, and was killed by Daniel in self defense. Daniel continued to be popular with the people; he became the Lord of Rasalhague, an independent Rasalhague, until 2487, when he died in a climbing accident at the age of one hundred and ten.

As an interlude in the Sorenson saga, finally the Lyran Commonwealth here makes its first appearance in the still-free Principality of Rasalhague. In 2463 House Steiner forces seized the worlds of Nox and Skandia, continuing to hold them until February 15, 2475. Up until this point only the Lyrans had been really effective in using the new war machine of the age — the BattleMech. On this date, the first 'Mech vs 'Mech battle took place, on Nox. The Lyrans were thrown off their captured planets in short order.

Many historians view the next series of events as the most critical in the history both of Rasalhague and of the Draconis Combine. To understand this we must go back in time slightly. In 2421, during the month of March, Nihongi Von Rohrs killed Parker Kurita and became the Coordinator of the Draconis Combine; his family ruled for the next eighty-nine years.

In the year of 2494, a romance was budding on Rasalhague, a romance between Martin McAllister, the Draconis diplomatic envoy to Rasalhague, and Illiyana Sorenson, the daughter of Blaine Sorenson, Lord of the Principality of Rasalhague. It was love at first sight for both of them. The two were secretly married two months later with the blessings of Blaine, on the condition that Martin must take a genetics test. Of course Martin agreed to this. The results had not yet been revealed.

Over the next few years, Martin had visited his wife several times on the pretence of meeting with Lord Sorenson. In February, 2496. Illiyana gave birth to Siriwan McAllister. In 2499 Illiyana was killed in a waterskiing accident. And so Lord Sorenson took the three-year-old Siriwan in and raised her along with his daughter Zarabeth who was close to the same age.

In 2501 Coordinator Von Rohrs decided to solve the Rasalhague problem with a military solution. Martin McAllister rejoined the Draconis military and rose through the ranks over the next seven years until he reached the position of Colonel in the Household Guard. There he bided his time.

On November 23, 2510, Martin McAllister killed Coordinator Von Rohrs. The next day he announced himself as a direct descendant of Shiro Kurita, citing the results of the genetic examination. On this day the Principality of Rasalhague was brought into the Draconis Combine not by a force of arms, but as a promise made between father-in-law and son-in-law many years ago. And Blaine Sorenson became Duke of Rasalhague.

The later history of Siriwan McAllister-Kurita is too complex to include here. But it is well worth the study of any

serious student of history — or lover of the dramatic.

Rasalhague remained peaceful as part of the Combine for a long time — over fifty years. It could not be expected that the freedom loving, stubbornly independent Rasalhaguians would be content as part of the regimented House Kurita. In 2583, Rasalhague guerilla fighters on the world of New Oslo broke up into small groups in order to harass the Kurita forces onplanet. By guile, endurance, and a determination which ignored the cost in blood, the small groups of thirty to fifty terrorists kept the Draconians in complete disarray for two and a half months. Throughout out this time the Dracos took out their frustration on the populace. But then the terrorists became overconfident. In their anger at the reprisals inflicted on the locals, they assaulted the garrison, which was expecting this reaction. The Kuritans wiped them out to the last freedom fighter.

The year of 2634 had become the year of pirates. Several worlds were attacked by various pirate groups. Somehow they were able to completely avoid the Kuritan forces, but the underground used more creative search procedures, and more innovative antiMech techniques. A primary example was the giant tiger trap which was six meters deep and ten meters wide, lined on the bottom with explosive. The BattleMech would step down or fall down into the hole; the following explosions would usually render the 'Mech's legs useless, but leave the pilot alive for questioning. Using this technique and others like it, the underground was usually able to stop a raid before anyone was really harmed.

July 14, 2694, is a date all Rasalhaguians will remember. This date marks the night assault on the world of Svelvik. What makes this particular attack so special? It was done with hydrofoils under the Rebel leader Gustav Torsten. The Kurita garrison headquarters was on an island which the Draconians considered safer than the mainland. They felt the island to be a place no terrorists could attack. So Gustav loaded his troops into the hydrofoils and went out to attack the garrison command. After a six-hour battle the hydrofoils were repulsed by aerospace fighters. The Rebels were hardly damaged; they were able to attack the garrison two more times that month before they were destroyed.

In 2702, the Star League's Third Regimental Combat Team was sent to Rasalhague. Throughout their stay, they continued troop training, which caused many of the locals to believe that they were an occupation force which had been sent to ensure no insurrections from this portion of the Inner Sphere. This tension increased until the year 2749 when assassins from the Prince of Rasalhague killed the Commander of the Third RCT. This mobilized the entire Combat Team. They descended upon the major cities and kept everyone on edge, actually hoping that the Draconians would come and help get rid of these Star League bravos. The Rasalhague troops were unable to deal with these Star

League Elites. The truly unfortunate part was that when the Kuritan troops tried to get rid of the Third RCT they failed miserably. So another chance for a closer relationship between Rasalhague and the Dracos was lost. The Prince was forced to execute the assassins to placate the Third RCT.

The Third RCT was again involved with the history of Rasalhague in 2798. The Eighth and Fiftieth Battalions were engaged in a vengeance mission against Draconis warriors on the planet Sendai. Forces from Rasalhague were sent to aid the planetary forces. When they learned the reason for the vengeance, the massacre of the dependents of the Third RCT, the Rasalhaguians refused aid and left the system. This was a clear case of honorable blood feud, an ancient tradition of their first homelands.

Next came the Minnesota Tribe incidents of 2825. The first appearance of this group of unknown mechwarriors who

slaves. There was nothing they could do. The pirates continued to spread death and destruction everywhere they went until they left Rasalhague.

A major event happened in 2850, known to history as the Snowfire Incident. Snowfire was a Rasalhaguian who had been trained by the Lyran Intelligence Corps and placed in a Rasalhague Ukiyo. Eventually she attracted the attention of the Coordinator of the Draconis Combine. When she received her orders to kill him, she quietly and efficiently completed the task. The reprisal which followed afterwards had no effect on Rasalhague, but the Lyrans paid dearly.

In 2862 one of the Light Rasalhague Regular BattleMech Battalions was badly mauled during the Second Succession War because the Kuritans had not supplied it properly. As a reaction to this the Rasalhague Rebels opened a black market trade with various free traders from the Lyran Com-

They were then able to claim the DropShip under *maritime salvage laws!*

fought like a Regular army unit began on the world of Svelvik, where they took on supplies and easily eliminated the defense garrison while making sure that no civilians were hurt in any of the fighting. The second appearance of the tribe was on the prefecture capital of Trondheim. Those of the Twentieth Rasalhague Regulars who survived the battle seemed to think that the Minnesota Tribe was just challenging them to a fight to test their strengths and weaknesses. At this point the Rasalhague Military District was placed on the highest state of alert. The last attack of the Minnesota Tribe was on the world of Richmond; they freed many thousands of prisoners who were then landed into DropShips and never heard from again.

Of course these ghost regiments are not the only attackers who have targeted Rasalhague for their depredations. Rasalhague, on the edge of the Periphery, has long been a buffer keeping the rich interior worlds of the Inner Sphere from attack, suffering itself as a consequence. One of the worst examples came in the year 2831; the pirates of Oberon VI attacked the planet of Rasalhague. After a week of pillaging they left with many captives. Families once again saw their loved ones looking forward to a hopeless future as

monwealth for many goods, including food. This upset the Combine, and they used this and other imagined outrages as pretexts to attack the Lyrans once again.

The next horrific event which plagued Rasalhague was the little known War of Clubs. This was a war between the various Rasalhague resistance groups on how to deal with (as they had come to be perceived) the Kuritan invaders. The arguments went from verbal to violent in a rather short period of time. This hidden war began in 2913 and ended finally in 2919. The reason it was called the 'War of Clubs' was that most of the fighting between the groups was done with melee weapons. Fortunately, in 2919 one Stefan Paulson was able to pull the groups together so they could once again start fighting the common enemy instead of each other.

The years of 2977-8 showed how fiercely the people of Rasalhague wanted their heritage and their freedom. House Kurita attempted to make Japanese the only language in all of Draconis space, enforcing it on the Rasalhague district. There were a multitude of angry demonstrations against this new change being imposed on Rasalhague. The upshot was that the Coordinator rescinded that rule, and relative peace

came back to the region.

The last thirty-five years have been the most hectic of all for the Rasalhague province. It began in the year 3000 when Talon Sergeant Ingmar Stevenson of the Otomo assassinated Coordinator Hohiro Kurita; his sword placed Takashi Kurita on the throne. Sergeant Stevenson died with the words, "Independence for Rasalhague!" on his lips.

If one Coordinator can be killed, another can also die. 3019 was the year when Prince Theodore Kurita was to marry the daughter of a high-ranking official in the Rasalhague court, to renew the ties between the province and the rest of the realm. Of course Coordinator Takashi came to witness the wedding, allowing the assassins to strike at the time when he was most at risk as his DropShip entered the atmosphere. An assassin placed a bomb on board which destroyed the engineering section. He sabotaged the bridge controls and the lifeboat controls so there could be no escape. He did not take into account Ivan Sorenson's Grasshopper. Ivan, also a passenger, used his 'Mech to escape the deathtrap. By using his jumpjets, he conveyed the Coordinator to the ground safely. His Grasshopper was destroyed by the impact. Because of his heroism, Ivan was made Lord of Rasalhague. Theodore Kurita's bride to be was executed along with her family. Although the young woman was almost certainly innocent, her father was one of the instigators of the plot against the Coordinator.

In 3020 a humorous event softened the grim account of Rasalhague's history. On Skandia, a mercenary unit called the Kell Hounds went raiding. They were able to capture a Leopard class DropShip, the *Kerasau*. It had not been taken in battle, so their employer had first claim on the ship. By quickly digging a canal from the Isbjorn Fiord to the crash location, the unit made a shallow sea. They were then able to claim the DropShip under *maritime* salvage laws!

The years just preceding the Fourth Succession War were vital to the formation of what we know now as the Free Rasalhague Republic. It began in the year 3026-27 when the Alshain People's Movement was led by the mysterious Silver Fox, who kept the attention of the Draconis Combine while the people who were to form the famous — or infamous — Tyr Regiments quietly left the province and began training in the Lyran Commonwealth. The next major event was when the Rasalhague resistance leaders' met with the Lyrans on Tamar to make plans for the coming war. The target worlds were: Harvest, Basiliano, Wheel, Kirchbach, Engadin, Gunzburg, Stanzach, and The Edge. Finally documents were signed recognizing the Tyr as the Rasalhaguian Government in Exile. After the war, in 3031, Duke Kelswa ordered his own people to take over the worlds taken by the Lyrans which had been promised to the Tyr. The Tyr retaliated as Rasalhaguians had done for centuries against the Draconis Combine, by attacking several government buildings. Duke Selwin reacted just as the Kuritans had done; he killed many of the rebels and jailed the leaders. They were soon released, but the Tyr were now disenchanted with the Lyran Commonwealth.

And so we come to March 13, 3034, when the Free Rasalhague Republic was declared. ComStar and the Draconis Combine quickly acknowledged their independence, and the Coordinator gave up several worlds as a show of faith to the new Republic. This in turn forced the Lyrans to honor their agreement to the Tyr government-in-exile or (as Katrina Steiner was happy to point out) they would all look like fools. As the eventful year of 3035 ends, the Ronin Wars have been brought to a close, and the Kungsarmee has had its baptism by fire, with the help of both Lyran and Draconis forces. Since there has been such a long rocky history for the Rasalhaguians, it is to be hoped that the future will be better for the people of this new Republic.

Johann Sorenson is a remote descendant of Daniel Sorenson, and fourth cousin to the late warlord Ivan Sorenson. He is a professor of history at the University of Trondheim.

As with so many citizens of Rasalhague, Professor Sorenson's loyalty to the new state is unswerving. And also as with so many others, he has kin who felt compelled by duty and by tradition to maintain their allegiance to House Kurita. He therefore has a brother who is a captain in the 3rd Benjamin Regulars, a married sister living on Alshain...and two brothers who serve with the Kungsarmee, one on Altenmarkt and the other with the forces of Major Knute Kurita on Last Frontier. Professor Sorenson goes into so much personal detail to remind his readers that the cost of the republic has been high, and that prejudice against the honorable choices of other hearts should not be tolerated.

(Major Kurita, our readers will remember, is the son of Mies Kurita. This branch of the Kurita family has lived in and often been officials in the Rasalhague district for the past several generations. He did not go through the formality of joining the anti-Ronin forces, simply showed up in his Thunderbolt and began to fight. The situation was later regularized when Knute Kurita was offered his present rank, and the command of a company of heavy 'Mechs. The company had been trained by *Chu-i* Tasha Greer, who now returns to the 8th Alshain Regulars, based in Buckminster.)



Me

Assassin!

A MechWarrior Scenario of Court Intrigue

Note: *The material in this scenario is for the MechWarrior referee's use only! The referee should arrange the presentation of this scenario in such a way that the characters do not know in advance the contents of this scenario. This may mean obtaining the players' promises that they will not read the following material until the adventure has been completed, or it may require that the referee change the names, etc, presented here in order to keep the vital element of surprise. The intrigue may be presented with a few changes at almost any small court, though it will not be as timely to 3034-35. Referee is urged to be completely familiar with this scenario before running it. Material on Canopus in the FASA sourcebooks *The Periphery* and *Twenty Year Update* will be helpful.*

This Mechwarrior scenario is set in the Magistracy of Canopus. The player characters witness an assassination attempt on the Magestrix, Kyalla Centrella. She asks the PCs for their help in uncovering the assassin's paymaster. As the players proceed they become entangled in the intricacies of the Canopian court.

The scenario is in four sections: Events, Investigations, Suspects, and Conclusion.

Events will occur throughout the investigation. These are vital to the plot. Each event is numbered; they should occur in numerical order through the scenario.

Investigations are undertaken by the players at the Magestrix's request. These include the results of players questioning suspects, searches, and suchlike.

Suspects will set out the statistics of Non-Player Characters, both opponents and allies of the PCs, with details of their behavior and motivation.

Conclusion The outcome of the PCs investigations should reveal the person behind the plot. The PCs must find proof, or get the plotter to reveal himself. There is a second perpetrator whom the players may discover. The Magestrix should reward them suitably; she will not try to cheat them; she will be grateful.

Assassin! is intended for two to six players; four is ideal. It is suitable for less experienced players. If the experience level is high, or if there are more players added, increase the skills of the opponents in any combats.

Unless you wish to create a unit which is part of the permanent forces of the Magistracy of Canopus, assume that the PCs are mercenaries in the service of the Magistracy. They have just concluded a campaign (not against the Free Worlds League, but any other opponent is fine), and are representing their unit at an award ceremony.

Events:

Event 1: Assassin

The PCs stand on the steps of the dais beneath the gaze of Kyalla Centrella. Their weapons were taken from them as they entered the throne room, and placed in a locker in the foyer by a steward. (Everyone else's weapon was similarly treated). (On a successful LRN roll in the throne room, the PCs will notice two crossed swords behind the throne, ceremonial cutlasses.) The Magestrix is just about to pin their awards onto their uniforms when two shots ring out. Two bullets slam into the throne just behind the Magestrix. Immediately, the throne room comes alive. (On a Dex plus 2 roll, the PCs may attempt to grab the cutlasses). Four guards rush to the dais and shepherd the Magestrix through the door behind it, protecting her with their bodies. Members of the court mill around in confusion and fear. Two guards struggle to push the heavy doors closed at the far end of the throne room.

Now the PCs spot the assassin running. He dodges through the gap between the huge wooden doors D as they are closing and sprints away. Nobody chases him. Encourage the players to give chase. It takes 2MP to move through the crowded room at a walk and 3 MP using any other movement option. Door C is barred from the other side, if anyone tries it. The guards will have opened the doors again by the time the PCs reach them; the guards will follow the PCs into the foyer. As the PCs leave the room, they will be fired on by the assassin, who is kneeling at point A, and who has taken careful aim at the point where the PCs come through the curtain. He will then run away down the corridor.

If it occurs to the PCs to retrieve their weapons, the steward who has the combination to the weapons locker will be in shock; he will not be able to get their weapons for them at this time.

Whether or not they lose time trying to recover their personal weapons, the assassin will be out of sight for a few vital moments. He will be found dead at point B. He was killed by a laser shot in the face. His features have been obliterated; of course he has no ID. There is no sign of the assailant or the weapon. Several doors and cross-corridors open out of the corridor he is found in. The players will not find any trace of

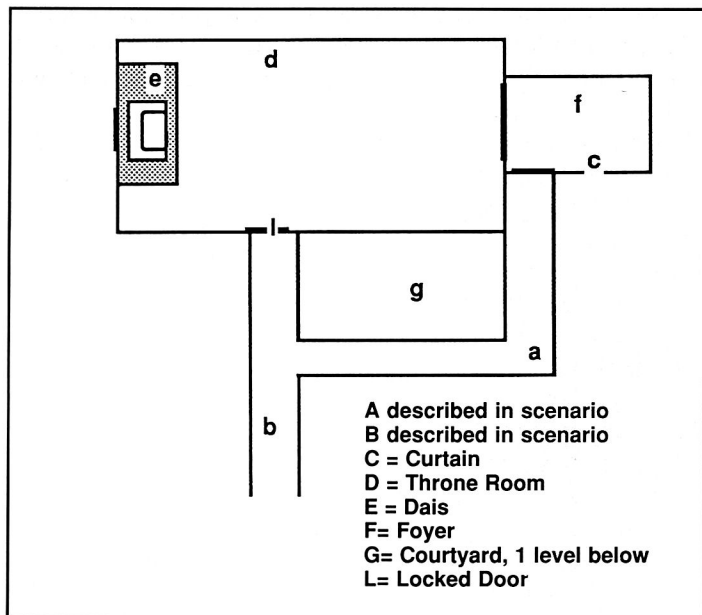

Throne Room and Rooms Around It

the assassin's killer.

The assassin's death is necessary to the scenario. If the players manage to capture him, the palace guards will take him from them immediately, and the PCs summoned to the Magestrix. He will not be questioned. He will be killed by persons unknown before he can be interrogated.

Event 2: Consultation with the Magestrix

Almost immediately following Event 1, the PCs are given a message by a page. It is from the Magestrix, requesting that they follow the page to her chambers. They will not be allowed to bear arms in her chambers.

She thanks them for coming, and tells them she needs their help. One attempt has been made on her life; she believes there will be more. She has many enemies in the court, one or more of whom must be behind the attempt. She needs the PCs to undertake the investigation because they will not be mixed up in the politics of the court, so she can count on their loyalty.

If the players are unaware of the assassin's death, she will tell them. She makes no mention of payment, but if the PCs press the matter she will offer 5,000 C-bills for each of them. She will supply them with a list of her prime suspects.

Finally she tells them to conceal the fact that she has employed them. She chooses the male PC with the highest charisma to be their contact. She will pretend to an intimate relationship with him to avoid suspicion; he will have to sleep in her chambers (on the couch), and sit next to her at tonight's banquet. Rooms will be made available in the palace for the other PCs.

Event 3: The Banquet

The banquet, followed by a ball, is in honor of the Ambassador from the Free Worlds League. Everyone who is anybody will be there. This is an ideal opportunity for the PCs to question suspects or informants. Most of the suspects are present.

There is poison in the Magestrix' food. It is slow-acting, so it will not affect her until the ball. She opens the ball (dancing with the Ambassador), then circulates. If any of the PCs asks her to dance, she will, but otherwise she talks to one guest after another for about an hour. She then begins to feel ill. She will leave the ball to consult her personal physician. He administers an antidote, then informs her 'lover', the PC. She is confined to her bed while she recovers.

Next, one of the PCs is approached by a female servant named Tau Pok. She uses all her abilities to become friendly with him. She tries to get him to discuss the Magestrix' secret hoard of 'Mech parts. She is a ROM agent; she has nothing to do with the assassination attempt.

Event 4: The Arrest

At court the next morning, Emma Centrella takes her mother's place. She announces that her mother was poisoned, but she is recovering. The poison taster has been arrested. She then adjourns the session.

Schedule of Events

Day 1

- 10:00 Court begins
- 10:30 The medal ceremony for the PCs
- 10:41 Two shots fired
- 10:56 The PCs summoned to the Magestrix
- 12:30 Baron Varna meets with Tara Yamora
- 14:45 Baron Varna meets with Tara Yamora again
- 17:30 Baron Varna meets with Lord Kerlin
- 20:30 The banquet begins
- 22:00 The ball commences.
- 23:25 Magestrix leaves the ball to consult her doctor

Day 2

- 2:00 The ball ends
- 11:00 Court opens
- 13:00 Baron Varna leaves the palace for three hours
- 17:00 Lange challenges the PC to a duel
- 23:00 Baron Varna meets with Lord Kerlin

Investigations

The following lines of investigation yield results:

Servants' gossip (some true, some false)

- 1) Emma Centrella is having an affair with Baron Varna; her mother does not know.
- 2) The head housekeeper, Tara Yamora, is also having an affair with Baron Varna.

3) Captain Quon, the Magestrix' former favorite, is plotting to kill her.

4) The kitchen staff saw Tara Yamora at the Sniffer cabinet.

5) Baron Varna inspected the preparations for the banquet; he has done this often.

The Food Tester

1) Only he and Tara Yamora have keys for the cabinet in which the Sniffer is kept.

2) The Sniffer was used by him; it indicated that the food was safe.

3) He believes that the Sniffer was tampered with.

Following the Suspects

Most of the suspects remain in their rooms, performing their duties to the court or to their own holdings. (There is a large amount of paperwork to administration).

On Day 1, Baron Varna meets with Lord Kerlin once and Tara Yamora twice. At his first meeting with her (12:30), day 1 he gives her a dummy Sniffer to replace the real one. At their second meeting she gives him the real one. On the afternoon of Day 2, he will go into the poorer regions of the city to make arrangements with his other killer.

Searching Baron Varna's Office

The PCs will find the real poison Sniffer in a cupboard under some papers. They will not recognize what it is unless they make an LRN roll at plus 4, or unless it has been described to them in some other part of the investigation. This one functions when a 10 or better is rolled (it has not been serviced in centuries).

The Sniffer in the dining room cabinet

The poison Sniffer is a tube about 10cm long and 4 cm in diameter. It is passed over food; it beeps a warning if one of the 300-odd known poisons is present. Sniffers were a product of Star League technology; they have not been manufactured in over four hundred years. There are none known to exist in working order. If this one (the false one) is investigated, it will be found to be non-functional.

Being Followed

One or more of the PCs are followed during their investigations. A successful Listen saving roll will alert the PCs to Baron Calima's presence. When questioned, he will say that he worked out what the PCs must be doing. He was following them, hoping to find the identity of the conspirator in order to help the conspirator.

The Suspects:

The suspects whose names are marked with an asterix are those whose names appear on the Magistrix's list given to the PCs.

Baron Calima*

A little man with beady eyes and short, dark, greasy hair. Formerly a Duke, he was stripped of most of his titles when

he was found to be plotting to overthrow the Magestrix. He is trying to locate the man behind the plot in order to join him.

Stats	Significant Skills	Level	Target Number
BODY 5	Diplomacy	5	5
DEX 7	Land Management	3	4
LRN 10	Rogue	2	
CHA 4	Listen/Eavesdrop	2	6
	Stealth	2	6
	Bribery	2	6

Count Moloq*

A tall man with a proud bearing, he is grey-haired and balding.

He is the Magestrix's most influential political enemy. He opposes her moves against the Free Worlds League, fearing that involvement in Andurien independence will destroy Canopus. He is not involved in the assassination, but her death would be very convenient for him.

Stats	Significant Skills	Level	Target Number
BODY 6	Diplomacy	6	2
DEX 6	Land Management	7	1
LRN 9	Leadership	2	6
CHA 8			

Count Laxa*

Average height, but muscular and powerfully built. His eyes seem to miss nothing. A former MechWarrior who believes the Magestrix was responsible for the death of a friend in battle. He can be used by anyone who wishes to kill her, but he had nothing to do with the attempt.

Stats	Significant Skills	Level	Target Number
BODY 8	Bow/Blade	3	5
DEX 8	Gunnery/Mech	6	2
LRN 9	Leadership	2	6
CHA 8	Pilot/Mech	5	3
	Pistol	2	6

Captain Quon*

Tall and muscular, handsome. The Magestrix's former favorite, who is jealous of her current lover, Colonel Lange. He is planning to kill Lange, but he is loyal to the Magestrix and may even aid the PCs if he's approached properly. He saw Tara Yamora meet with Baron Varna the second time; he saw her hand him something in a bag. He will not remember this unless he is trying to aid the PCs.

Stats	Significant Skills	Level	Target Number
BODY 8	Bow/Blade	5	3
DEX 9	Pilot/Mech	5	3
LRN 7	Gunnery/Mech	6	2
CHA 10	Pistol	6	2
	Tactics	3	5

Baron Varna*

Medium build, curly black hair and beard. He is about forty years old.



Baron Varna

He is very ambitious and wants to rule the Magistracy. He hired and killed the assassin. He used Tara Yamora to switch the Sniffer for a fake, and poisoned the Magestrix's food. He intends to marry Emma to gain control of the throne.

Baron Varna continued

Stats		Significant Skills	Level	Target Number
BODY	9	Bow/Blade	5	3
DEX	9	Diplomacy	7	2
LRN	10	Land Management	6	2
CHA	10	Rogue	3	
		Listen/Eavesdrop	3	5
		Stealth	3	5
		Bribery	3	5
		Forgery	2	6
		Disguise	1	7
		Streetwise	6	1

Emma Centrella*

Daughter to the Magestrix and heir to her throne. Cute rather than beautiful. Dusky complexion, long curly dark hair. She is blunt and honest, though quite intelligent. She wants a more active role in the Magistracy. She is having an affair with Baron Varna which her mother actually does not know about. She believes he loves her. She has no intention of marrying him. She is impulsive, laughs readily, and trusts no one at court. If the Magestrix is attacked in her presence, Emma will fight to save her.

Stats		Significant Skills	Level	Target Number
BODY	10	Bow/Blade	1	7
DEX	9	Diplomacy	3	5
LRN	9	Land Management	4	3
CHA	8	Rogue	2	
		Listen/Eavesdrop	3	5
		Security Systems	3	5
		Bribery	3	5

Colonel Lange

Medium height, good looking, graceful. The Magestrix' current favorite. He is jealous of the PC who is pretending to replace him (he does not know the truth). He will challenge the PC to a non-lethal duel with swords or 'Mechs, PC gets the choice as challenged party. He pilots an Archer.

Stats		Significant Skills	Level	Target Number
BODY	8	Bow/Blade	5	3
DEX	9	Pilot/Mech	5	3
LRN	7	Gunnery/Mech	6	2
CHA	10	Pistol	6	2
		Tactics	3	5

Femme (or Homme) Fatale

If the investigations continue into Day 3, Baron Varna will blackmail a minor noble. The noble, male or female as appropriate, is to seduce a PC and murder him or her. The noble's name is Sir or Dame Samtox.

Tara Yamora

The housekeeper was raised on the estates of Baron Varna. Her loyalty is to him rather than to the Magestrix. She distrusts Lord Kerlin. The players may be able to play on that distrust.

Stats	Significant Skills	Level	Target Number
BODY 8	Accounting	6	4
DEX 9	Brawl	3	1
LRN 6	Backstairs	2	8
CHA 6	(Backstairs is a skill like Streetwise or Diplomacy; it is usable only by servants in great houses. For every 3 levels of Backstairs, 1 level of Interrogation is given (a gossip skill)).		

Lord Kerlin

A tall and imposing man in his fifties. He is the Ambassador from the Free Worlds League. He is behind Varna's plot. He has convinced Varna that House Marik will aid him, but his intention is to unbalance Canopus so it will not aid Andurien. It is unlikely that the PCs will actually uncover his role.

Stats	Significant Skills	Level	Target Number
BODY 8	Bow/Blade	5	3
DEX 9	Diplomacy	5	3
LRN 10	Pilot/Mech	6	2
CHA 10	Pistol	6	2
	Tactics	5	3

Conclusion:

The PCs will probably have concluded that the man behind the assassination attempts is Baron Varna. This should be reported to the Magestrix, however, the Baron's final attempt is still to be prevented. She will ask them to say nothing.

When the PCs' suspicions are reported, the Magestrix will gather all the PCs and Baron Varna in her chambers. Once again, the PCs' weapons are removed by the guard at the door. She will then instruct the PCs to tell Varna what they have learned. Once they have finished, Varna will say nothing, but will slump and playact defeat. The proceedings will be interrupted by a man posing as a messenger to the Magestrix. He is Varna's second assassin.

The assassin draws a laser pistol and shoots at the Magestrix. The PCs are the only ones who can stop him, and they must do so with their bare hands. During the confusion, Varna will attempt to shoot the Magestrix.

If the PCs fail, Baron Varna will accuse them of killing the Magestrix, and they will be arrested by the palace guards.

If they succeed, they will be heroes. The Magestrix will pay them each 7000 C-bills, and make each of them a knight, dividing a portion of Varna's lands between them.

Loose ends:

Varna, the assassin, the guard who allowed Varna to keep his gun, and any others who are implicated (Tara Yamora, unless the players have not mentioned her) are all

executed. The poison taster is released. If Lord Kerlin's involvement is proved, he is declared persona non grata and expelled. It becomes more likely that Canopus will aid Andurien.

Kyala Centrella

Magestrix of Canopus. Once a great beauty, she is still lovely, commanding, and impressive. She is subtle and intelligent; it seems she would rather work indirectly for the fun of it. She once fought in an infantry company. She is unmarried, preferring to take favorites as she chooses. She trusts no one, though she is genuinely fond of her daughter. She has a dry wit and is rather a good dancer.

Stats	Significant Skills	Level	Target Number
BODY 6	Bow/Blade	3	5
DEX 9	Diplomacy	5	3
LRN 10	Land Management	4	3
CHA 10	Rogue	3	
	Listen/Eavesdrop	4	4
	Security Systems	3	5
	Bribery	3	5
	Stealth	3	5

Her current HTK are only 35, due to the effects of the poison.

The Assassin

Stats	Significant Skills	Level	Target Number
BODY 6	Bow/Blade	5	3
DEX 8	Pistol	4	4
LRN 6	Brawling	5	3
CHA 5			

He carries a laser pistol and a knife

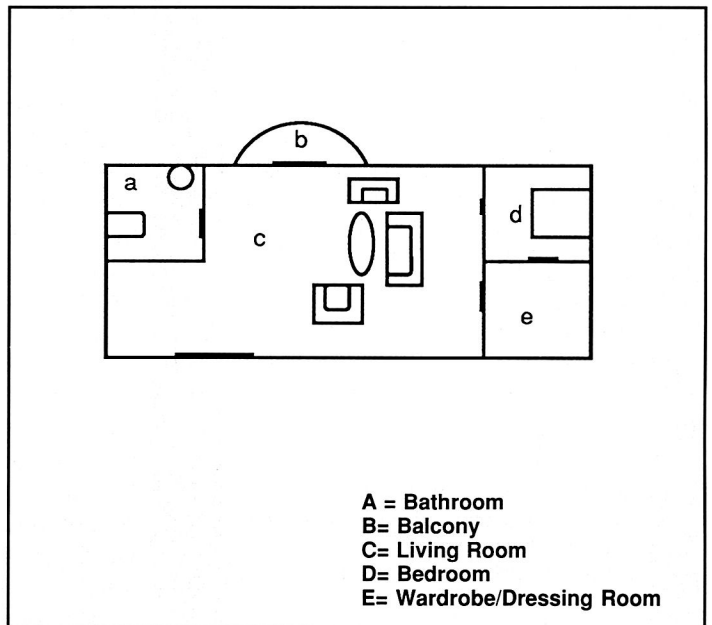

- A = Bathroom
- B = Balcony
- C = Living Room
- D = Bedroom
- E = Wardrobe/Dressing Room

The Magestrix's Chambers

Rift Into Hel

Interview continued from page 6

need to feel valued.

BT: Kadett-Lojtnent Lorenson, what is the strangest thing for you in dealing with the joint command?

Lorenson: Well, it gets interesting when either one of them gets upset; one swears in Japanese and the other swears in German. So we must be fluent in both languages! But actually, with Capt Hiro's emphasis on feedback, I see how his response to our comments improves our next battle. By Capt Rychek's non-emphasis on the uniform and protocol, we are shown that honors won in battle are not important. (Both officers look startled; Rychek indicates a question. Lorenson looks directly at the camera, speaking with great emphasis.) It is the people who are saved who are important.

BT: Capt Hiro, what is your response to the notion that the Free Republic has been allowed its independence so that it will serve as a 'buffer zone' to minimize hostile contact between the Lyrans and the Combine? Is Rasalhague a buffer zone?

Hiro: No, not just that. It is a state unto its own, though it will ensure that tensions that previously were between the Lyran Commonwealth and the Dragon's House will be lessened.

Rychek: (tonelessly) I'm certain that I hope that what Capt Hiro is saying will prove true.

Hiro: I think that relationships will improve, at least with the Lyran Commonwealth.

BT: Would either of you care to comment on the fact that it is now a matter of joint policy made by the new *Federated Commonwealth*, and that House Kurita now has Hanse Davion on both borders.

(Hiro gives a wave to indicate that Rychek may answer first.)

Rychek: Speaking as a Lyran now, let me state that policy will be made *by us*, not *for us*. Our Archon's policy, which I personally find admirable, calls for a strong defense, but a hope that the Inner Sphere can devote itself to more peaceful purposes. And a willingness to devote money and energy to those purposes. I don't mean to make a speech, but you asked.

continues...

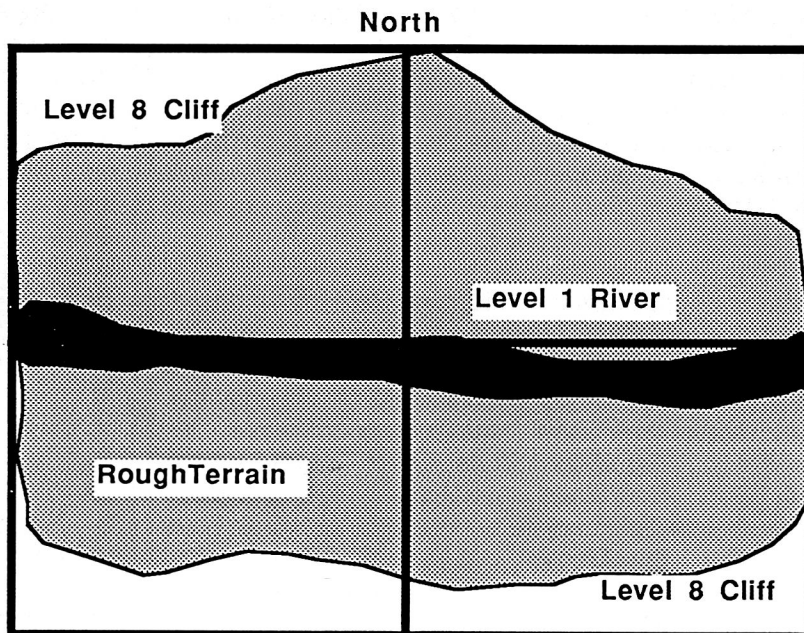

What was the most unusual occurrence during the year of 3035? Something that happened every day! The Kuritans and the Lyrans fighting side by side, to defend those combative people, the natives of Rasalhague. And whom were they fighting? More Kuritans! The traditional old-style Kurita military, many of whom revolted when the Draconis Combine allowed Rasalhague to proclaim its independence.. *Gunji no Kanrei* Theodore Kurita dubbed these rebels *ronin*, masterless. The name stuck. The Ronin Wars are now ended. Pictures from this time, showing officers from House Kurita and House Steiner leading into battle the native troops they had been training, conferring together, even amicably debating military tactics; these pictures will be looked upon with disbelief. 'Mechs painted the bright colors of the Steiner regiments fighting next to the black and blood red 'Mechs of the Draconians may never be seen again.

One of the most desperate of these joint missions happened on the planet Skandia, in the month of May. The ninety degree cliffs tower higher than a 'Mech can jump above a river canyon. The Midgard River is swift-running down the center. Here the Fire Lance and the Recon Lance of the Bravo Company, Third Tyr Regiment met a mixed Ronin unit which was determined to give no quarter. These fanatics refused surrender as unworthy of a warrior. The battle was long and bloody. None of the *ronin* survived. The survivors limped out the other end of the rift, to spend long weeks repairing 'Mechs and healing mechwarriors.

Game Set-up: Place four BattleTech mapboards side by side lengthwise. The terrain is rough. The mapsides are 90° cliffs that are 8 levels high. There is a level one river running down the middle of the canyon.

Defender Set-up: The Rasalhague forces are defending. They may be set up on the south end of the board, anywhere in the first five hexes.

Fire Lance Commander:

Takashi Hiro, *Catapult* Piloting: 1, Gunnery: 2

Fire Lance:

Sven Lorensen, *Archer* Piloting: 3, Gunnery: 2

John Davidson, *Vindicator* Piloting: 5, Gunnery: 5

Mikial Silverton, *Archer* Piloting: 4, Gunnery: 6

Laura Micheaux, *Phoenix Hawk* Piloting: 5, Gunnery: 5

Recon Lance Commander:

Elizabeth Rychek, *Shadow Hawk* Piloting: 2, Gunnery: 2

Recon Lance:

David Shane, *Trebuchet* Piloting: 3, Gunnery: 4

Kimi Ohara, *Catapult* Piloting: 5, Gunnery: 5

Daniel Horgunse, *Panther* Piloting: 6, Gunnery: 4

Attacker Set-up: The Ronin unit, which is a mixed group, will come in from the North End. They can set up on the first three hexes.

Heavy Lance:

Miro Jiro, *Warhammer* Piloting: 2, Gunnery: 2

Okama Hiro, *Rifleman* Piloting: 3, Gunnery: 4

Johnathan Saracen, *Shadow Hawk* Piloting: 4, Gunnery: 3

Lisa Trebounet, *Crusader* Piloting: 4, Gunnery: 4

Jump Infantry Platoon:

21 men, armed with lasers

Heavy Hover Lance:

Condor Drive: 3, Gunnery: 5

Condor Drive: 5, Gunnery: 5

Condor Drive: 4, Gunnery: 4

Condor Drive: 4, Gunnery: 3

Victory Conditions:

This is a classic showdown situation at the bottom of one of the deep rifts that Skandia is famous for. Whoever is left at the end of the game is the winner.

Interview continues...

Hiro: As we saw when the Lyrans and the Federats first combined, they had an internal policy of 'let's try to conquer'. But if our dear neighbors have gotten the conquering urge out of their blood, the Inner Sphere will have a period of rest, for all of us need it.

BT: Kadett-Lojtnent Lorensen, on the day-to-day aspects of a mixed unit ...

Rychek: We agree not to talk politics! (All three laugh).

BT:... as most of our readers are warriors, they want to know how it can work in practice. What happens, for example, when someone messes up?

Lorensen: Actually, as I am senior Kadett, punishments are given to me to be handed out to the two training lances. That is part of my training as a leader. So no, no problems with punishments. Except that the unit may think I'm a little too strict, cutting firewood in the dead of winter.

BT: It was predicted that a mixed force such as yours would constantly find itself poorly supplied with rations that the soldiers wouldn't eat, batteries with the wrong mounts, the wrong ammunition for your weapons...

Hiro: Not under my command! And as far as I know, not under yours, Elizabeth! Unless there is something I haven't been told!

Rychek: But Takashi, technically I am under your command...

Hiro: The LCAF supplied the forces in their training companies. So if there was a problem, you should certainly have informed me.

Rychek: (opening eyes wide) I didn't mean to imply that there was a problem.

Lorensen: Ms Brandt, the reason we had so few problems was because we made sure that each 'Mech had the correct supplies before it was loaded on. We didn't need to have problems with malfunctioning weapons.

BT: Nothing went wrong? All was sweetness and light?

Lorensen: Of course things go wrong during training — and during training there's no such thing as sweetness and light. But the two forces cooperated very well in teaching us strategy and tactics. I find we have been very well trained. Don't you agree...Captains?

(The two eye each other. Both give a small nod of satisfaction.)

Outpost

September 11, 3033

Outpost Intercepted Transmissions

It is believed that the unknown bandit group used the designations of "Blackbeard" for their heavy 'Mechs, "Bluebeard" for their medium 'Mechs, and "Crow's Nest" for their light 'Mechs.

— Blackbeard One, this is Crow's Nest Leader. Receiving strange blips on all sensors. Apparent LAMs, coming this way. Over.

— Blackbeard One to Crow's Nest, what is the range and approximate time of arrival of incoming LAMs? Over

— Crow's Nest Leader to Blackbeard One, Range: 10 kilometers. Seem to be Phoenix Hawks. Over.

— Blackbeard One to Crow's Nest, what is estimated time of arrival and number of harrasing forces? Over

— Crow's Nest Leader to All Units, harrasing forces ar 4 LAMs; approximate time of arrival 3 minutes. Shouldn't be much of a problem with the forces at hand.

— — Elapsed Time — —

— — 2 minutes, 30 seconds — —

— Crow's Nest Leader to All Units, revise previous assumption. They aren't Phoenix Hawks. They are a sort of LAM I've never seen before. Could use assistance here as quickly as possible. Have lost Crow's Nest Two and Three to heavy laser fire. (Ragged breathing into mike) Over.

— Blackbeard One to Bluebeard Unit, move up to assist Crow's Nest. Prepare for LongRange Missile fire. Over.

Memory's Surprises

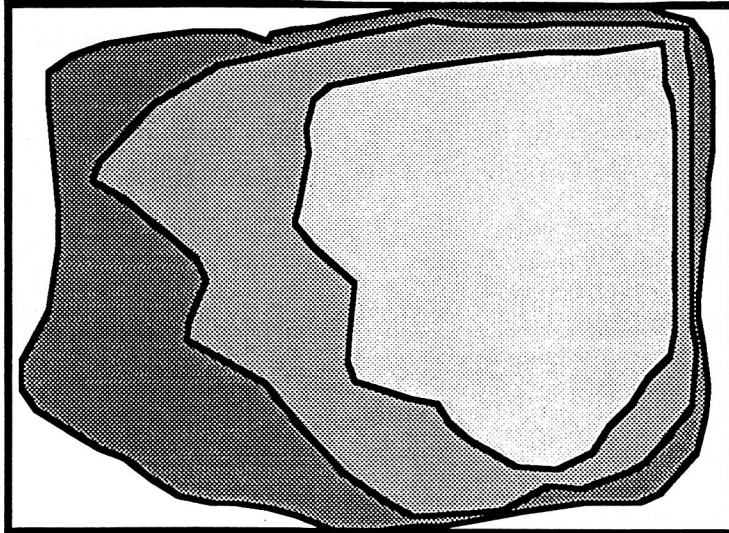

These color gradations represent differing types of rough terrain; If desired, consider each change as one level down to simulate difficulties such as adobe mud (something like an oil slick).

"The Munins were used with great effectiveness on the border world of Outpost where a group of unknown Periphery bandits attacked a Tyr base in 3033. A company of Medium and Heavy 'Mechs landed about sixty kilometers from the Tyr's base of operations. Four Munin LAMs were sent out to engage the bandits. The LAM lance met the attackers forty kilometers outside the base and harrassed the company for the next thirty-five kilometers. Of the four LAMs, only one made it back in a shape that could be considered operable. The Bandits lost seven of their 'Mechs and retreated toward their DropShip. They never made it. The remaining Munin LAM kept the Tyr forces informed of the bandits' location and located their DropShip, so the Tyr captured that as well.

Mechwarrior Dana Lorenson

Dana's Munin LAM, known as the Spiral, was the only LAM survivor from the raid on outpost. As both aerospace pilot and mechwarrior, she is one of the best in the Tyr, now the Kungsarmee. Mechwarrior Lorenson is now teaching new LAM pilots how to use their machines to maximum effect."

Thorkinsson's Unusual BattleMechs, Saso University Press, 3034 edition

Situation:

An unknown bandit group landed on the border world of Outpost to attack a Tyr secret base. They landed 60 kilometers away from the base, and began a forced march towards the base. The Tyr sent out a lance of their Munin LAMs to harrass these bandits.

Game Set-up:

Set up two BattleTech boards end to end lengthwise. Consider the board to be a "floating board" in which after the 'Mechs leave the edge of the map, place another board to match up with the board exited, and continue with the battle. All terrain is desert-like, which means rough terrain. Since the entire battle took place at night, there is a -2 to all heat levels, because of the coolness of the night desert.

Attacker Set-up:

The Recon Lance sets up first on the first board. The bandits continue heading south until their victory conditions are met. After the third turn, roll 1 D6: on a roll of 5 or 6, one of the 'Mechs from the Medium or Heavy Lances will appear on the far end of the board.

Heavy Lance:

Shadow Hawk: Piloting: 3, Gunnery: 2

Phoenix Hawk: Piloting: 4, Gunnery: 4

Panther: Piloting: 3, Gunnery: 2

Griffin: Piloting: 5, Gunnery: 3

Medium Lance

Catapult: Piloting: 2, Gunnery: 3

Trebuchet: Piloting: 4, Gunnery: 5

Spider: Piloting: 3, Gunnery: 3

Dervish: Piloting: 3, Gunnery: 3

Recon Lance

Stinger: Piloting: 3, Gunnery: 2

Javelin: Piloting: 3, Gunnery: 5

Cicada: Piloting: 4, Gunnery: 4

Locust: Piloting: 4, Gunnery: 3

Defender Set-up:

The Munin LAMs are coming from the southern end of the board. They must continue fighting until one or another of the victory conditions are met.

Lt Haakon Halverson, *Munin LAM* Piloting: 2, Gunnery: 2

MechWarrior Dana Lorenson, *Munin LAM* Piloting: 2, Gunnery: 3

MechWarrior Soral Lundgren, *Munin LAM* Piloting: 3, Gunnery: 3

MechWarrior Daniel Akramov, *Munin LAM* Piloting: 3, Gunnery: 2

Victory Conditions:

The Attackers win if they eliminate all of the Defenders. The Defenders win if they are able to destroy or disable 7 of the bandit 'Mechs; this forces the bandits to retreat back to their DropShip.

— Bluebeard Leader to Blackbeard One, affirmative. Over.

— Crow's Nest Leader to All Units, the new LAM appears to be built on a Phoenix Hawk frame, but has a full complement of laser weapons. And they seem not to know the meaning of the word "fear". Am last one left of unit.. (Transmission from Crow's Nest Leader breaks off. Sounds of laser fire.)

— Bluebeard Leader to Blackbeard One, Have set up to receive approaching LAMs with appropriate missile fire. (Sounds in background of missiles being launched). Have launched full complement of missiles; the swarm seems to be working well. They seem to have retreated for a short time. Have eliminated one of the units. Over.

— Blackbeard One to Bluebeard Lance, good work! Continue your fire until the other three units are destroyed and we should have an easy time at the base. Blackbeard Three, take up a rearguard position and alert us of any forces that may be coming. Over.

— Bluebeard Four to remaining units, LAMs apparently gone out of visual range. Look alive!

— Blackbeard Three to All Units, Aerospace fighters coming down! OH MY G.. (Sounds of several explosions. Transmission ends.)

Technical Readout

MN-1B Munin LAM

During the Fourth Succession War, several Kurita and Steiner units reported the presence of what seemed to be Phoenix Hawk LAMS doing various types of reconnaissance and assisting the various Tyr undergrounds in their operations. As it turned out, the Tyr had found a cache of what is now believed to be the predecessor of the Phoenix Hawk LAM. This 'new' LAM has been classified as the Munin LAM, named for Munin (memory), one of Odin's ravens. During the five year period following the war, the Munin LAMs were used to keep the Draconis Combine offbalance in the Rasalhague district.

The Munins were used with great effectiveness on the border world of Outpost (see scenario on page 52). where a group of unknown Periphery bandits attacked a Tyr base in 3033.

Technical Aspects:

The interesting differences between the Munin LAM and its better-known successor the Phoenix Hawk LAM are fascinating. The chassis is quite similar. The first major difference is the engine. Instead of the Phoenix Hawk LAM's 270 GM, the Munin LAM uses a 225 VOX, which cuts down on the speed by 11 kph. This opens up a perfect spot for the Land Air Mech Conversion Equipment. Some interesting heat problems are caused by this placement which required more heat sinks than the Phoenix Hawk LAM's.

Some of the disadvantages of this model show up in the Duralex Light Armor System. The armor had to be lighter to insure that the extra heat sinks and the conversion equipment are able to do their jobs efficiently. Of course the Munin LAM has the same problem as other LAMs; the delicacy of the conversion equipment. That can't be solved with present technology.

The weaponry on the Munin is as effective as anything to be found on any battlefield. The 1 Magna Mark III, 2 Magna Mark II's and a Magna Mark I laser are all linked, with the LOCKET targeting system. This targeting system seems to be one of the best: lines of sight are almost unparalleled.

Capabilities:

The Munin LAM is probably one of the more versatile LAMs that can be found in the Rasalhague worlds. It is most used as a reconnaissance unit, or as a rearguard mobile defense. Its slight reduction in speed on the ground is made up for when the LAM is in its AirMech form; it gets a speed of 162 kph versus the Phoenix Hawk's airspeed of 97.2 kph. The weaponry on the Munin LAM can have many advantages over the Phoenix Hawk. It has no chance of the deadly

ammunition explosions which plague so many BattleMechs in this day and time. The lasers are potentially more deadly, when taken in conjunction with the Star League LOCKET targeting system. It is theorized that this system has some sort of pinpoint targeting, but it is so delicate that none have survived in a destroyed 'Mech. The forces which possess intact Munins have not made one available for study.

A third factor which gives the Munin a greater advantage is its heat sink system, which is greater than either the Phoenix Hawk or the Phoenix Hawk LAM's. In 'Mech form, there is a slight heat buildup which can be taken care of by judicious use of weaponry. On the other hand, in either Air Mech or Aerospace Fighter modes, the heat sink system provided by Isbjorn's Coolant Systems has no appreciable heat build up.

Variants:

A few variants can be seen. For example, the two Mark II lasers may be removed and replaced with a Power Punch SRM 6-pack. The punch is greater than the lasers', but it means that three of the heat sinks must be eliminated. This particular variant has been seen on the Steiner world of Hesperus II. Another variant replaces the Magna Mark I laser with a Holly LRM 10-pack and an ammo pack. This requires the elimination of one heat sink. This particular variant is said to have been seen in the Benjamin Military District of House Kurita.

Notable Mechs and Pilots:

Mechwarrior Hanse Marovsky

Hanse Marovsky and his Munin are well known in the Free Republic of Rasalhague. He is a scout along the Periphery border. He racked up a number of missions keeping tabs on the Pesht regiments during the Fourth Succession War. He may be the oldest mechwarrior in the Inner Sphere. It is said that he had had one career as a soldier for the Free Worlds League before he left with a bounty on his head. He is currently on indefinite leave along with his 'Mech.

MN-1B Munin LAM

Tonnage: 45 tons
 Chassis: Orguss Stinger
 Power Plant: VOX 225
 Manufacturer: Eldridge Industries
 Communications System: Tek BattleCom
 Targeting /
 Tracking System: LOCKET
 Cruising Speed: 54 kph
 Maximum Speed: 86.4 kph 'Mech Form
 Jet Propulsion System: Allied AVRTEch 100
 Air Cruising Speed: 900 kph
 Air Overthrust Speed: 1440 kph

Armor System: Duralex Light
 Armament: 1 Magna Mk I Heavy Laser
 2 Magna Mk II Medium Lasers
 1 Magna Mk III Light Laser
 Simulator Stats:
 Type: MN-1B Munin LAM Tons:
 Tonnage: 45 tons 45.0
 Internal Structure 4.5
 Engine VOX 225 10.0
 Walking MPs: 5
 Running MPs: 8
 Jumping MPs: 0
 Thrust: 5
 Overthrust: 8
 Cockpit: 3.0
 Gyro: 3.0
 Heat Sinks: 15 5.0

Armor:
 Armor Factor: 120 7.5
 Head: 3 9
 Center Torso: 14 20/5
 RT/Lt Torso: 11 14/4
 Rt/Lt Arm: 7 10
 RT/Lt Leg: 11 15

Weapons:	Location	Critical	Tons
Type:			
Large Laser	RA	2	5.0
Medium Laser	RA	1	1.0
Medium Laser	LA	1	1.0
Small Laser	LA	1	0.5
Conversion Equipment	CT	2	2.5
Conversion Equipment	RT	1	1.0
Conversion Equipment	LT	1	1.0

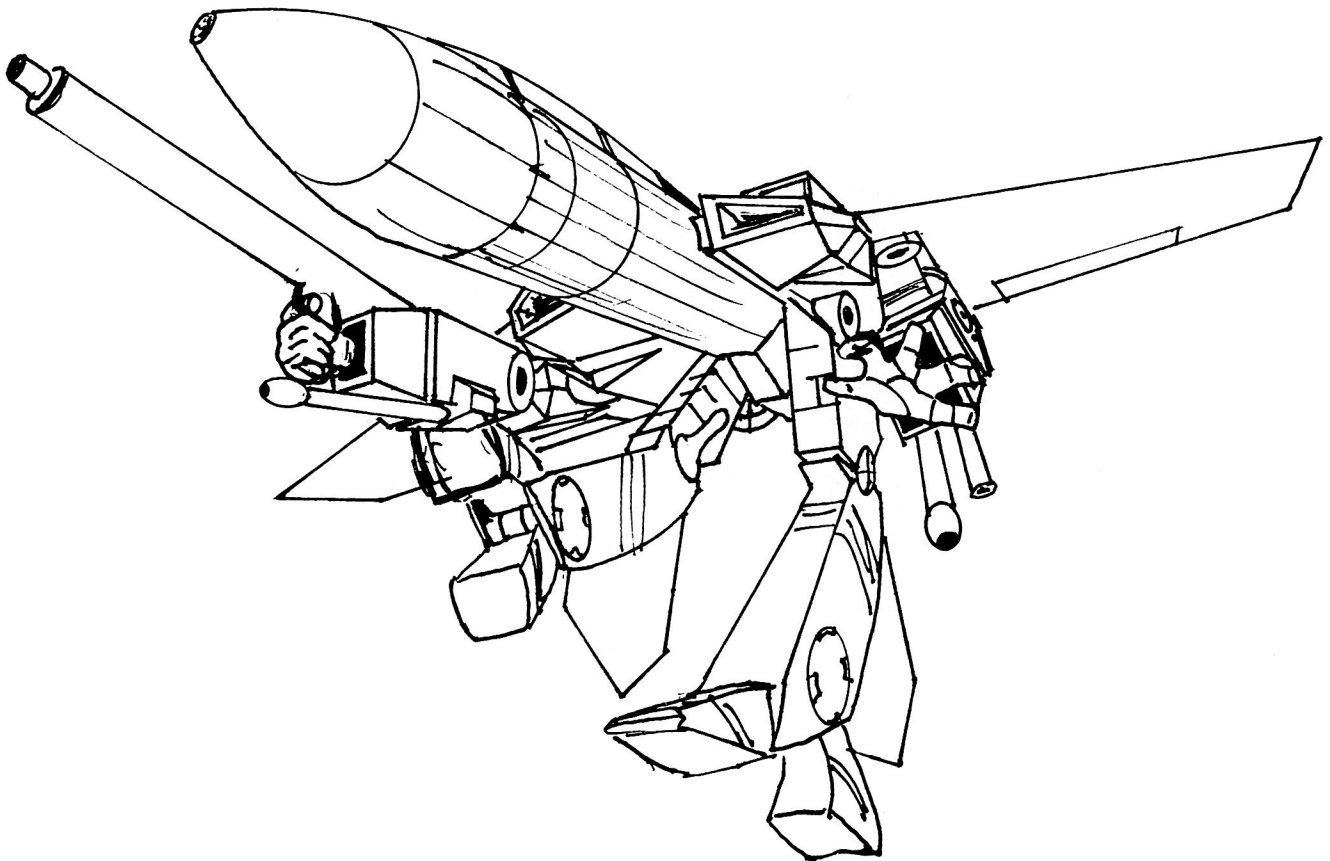

Introduction:

This scenario is an NAIS tactical combat training simulation for DropShip gunners and jump infantry. Its general purpose is to improve a warrior's skill in tactical combat situations, such as those that may be encountered after graduation and upon entering service with an active combat unit.

Some of these combat simulations will be historical reenactments (and will be described as such), but many others describe purely hypothetical confrontations. Some may even involve lances or companies from famous House or mercenary units. Most, however, will be strict simulations containing typical formations that might be found anywhere in the Successor States or even in the Periphery.

This particular scenario is intended for two players: one controlling the DropShip's weapons, and the other, the infantry battalions. For optimum training benefits, this scenario should be played twice, with players exchanging sides.

Slaughterhouse 3005

Background:

A DropShip, if surrounded by sufficient forces, may be destroyed on the ground before it is prepared for liftoff; at least, this can be done according to the tactical manuals. In practice, such opportunities are extremely rare. Vessels of this type are almost never found on the ground where they might be at risk. In addition, the craft is frequently well-guarded by supporting BattleMechs and tanks, and its own weapons are capable of a tenacious defense, threatening heavy casualties on any attacker.

Except in this situation — where a Leopard Class DropShip bearing enemy markings has been spotted on the ground in a relatively remote area of friendly territory. Presumably, the DropShip has landed for unknown reasons, unloaded its passengers, and is now trying to remain inconspicuous while awaiting their return. The only friendly forces available to dispatch are two reinforced battalions of missile-equipped infantry, which are immediately alerted and transported for a drop. Their mission is to land, engage the DropShip, and inflict as much damage as possible before the DropShip's passengers and escort return.

Game Set-Up:

This scenario uses CityTech and AeroTech rules and any BattleTech map of the Defending Player's choice. Any terrain features shown on the map should be treated as in effect. All combat units are considered to be in perfect working order or at full strength. The Defender sets up first and fires first.

Defender:

One Leopard Class DropShip (Gunnery 4)

The Defender may set up in any clear hex within four hexes of hex # 1517.

Attacker:

Two reinforced jump infantry battalions, each consisting of twelve

NAIS Training Simulation # 0093

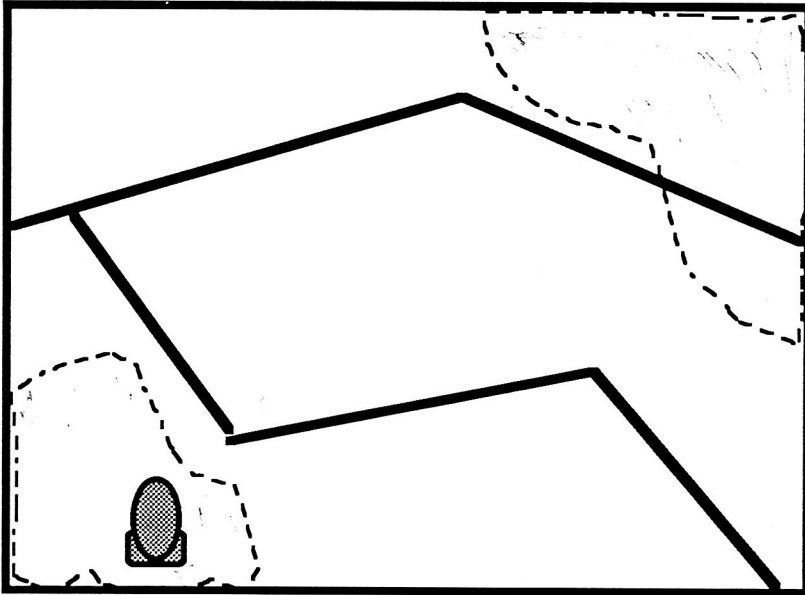

(12) SRM-equipped jump infantry platoons.

The infantry battalions are being air-dropped, with the landing zone immediately northwest of the DropShip. To simulate the scattering of such a landing, roll 1 D10 twice for each platoon to determine exactly where it landed. The first roll is for the first two digits, and the second roll for the second two digits of the hex number.

Special Rules:

The DropShip contains no small craft or other defending units. Its sole defense is its weapons. Once positioned, the DropShip may not move or change facing during the scenario.

Hits affecting the DropShip's control surfaces, bomb load, engines, and other systems may or may not affect the DropShip's performance while stationary on the ground. Common sense should be used when evaluating damage results. (For example, an engine explosion is still an engine explosion, even if the craft is grounded.)

Victory Conditions:

The scenario lasts ten turns, or until one side has been eliminated, whichever comes first. Victory Points for both sides are totalled up at the end of the scenario.

The Attacker receives 1 VP for every 5 point of armor damage (rounding down), 5 VP for every weapon disabled, and 10 VP for every engine or bridge critical hit inflicted.

The Defender receives 1 VP for every infantryman eliminated.

The side with the higher VP total wins (a tie means a draw). Divide the winning side's VP total by the losing side's VP total to determine the level of victory:

2.00 or greater: Strategic Victory
1.50 to 1.99: Operational Victory
1.25 to 1.49: Tactical Victory
1.01 to 1.24: Marginal Victory

Technical Readout

CRB-6S Cerberus

Overview:

The CBR-6S is unique in that it was produced entirely — engine, weapons, airframe and armor — by the same company, Cobalt Enterprises. No one has any idea of the ownership or location of Cobalt Enterprises. ComStar declines to state what knowledge they possess.

Capabilities:

The Cerberus was designed as an all-purpose attack craft. This would explain the name, which refers to the three-headed dog of the Greek underworld. Although most weapons with supposed “Jack of All Trades” capabilities, (like LAMs) perform at least some of these functions at a mediocre level, the Cerberus is the exception. It performs all of its tasks amazingly well.

For its weight the Cerberus is a marvel. It has the same armor a craft nearly twice as massive as itself, it is faster than most other fighters its size, it has a large fuel capacity (an average fighter, and it can inflict more damage than the other fighters in its class.

The CBR-6S was designed mainly for atmospheric combat. The air frame of the fighter enables the pilot to utilize the atmosphere to the fullest while maneuvering. Those who have flown the craft within atmosphere say that it is the smoothest handling ship they’ve ever piloted. They also point out that its space ride leaves much to be desired.

The Cerberus’s strafing attack is devastating, but the craft is still fast enough to carry heavy bombs. This makes the CBR-6S one of the most deadly air-support vehicles in existence.

The only major design flaw in the fighter is its problems with overheating. Fighters lose more heat sinks in battle than any other war machine does. As a fighter does not have enough sinks to begin with, the results can be disastrous.

Battle History:

As far as anyone can tell, the CRB-6S is a completely new design — one of the very few new designs of the past hundred years. The Cerberus appeared only three years ago under very odd circumstances.

During a Kurita raid on Cassias, a Davion border world

near the Periphery, a skirmish between a heavy company of Kuritan raiders and Davion militia was underway in a river valley. Suddenly and without warning, six CRB-6S’s screamed out of the sky from all directions. Each of the six fighters made a single strafing run on the river. Although the targets of this attack seemed to be entirely random, more Kuritan ‘Mechs than Davion were immobile when it ended.

The remaining fighter dropped a heavy smoke bomb into the fray, obscuring vision and sensors. When the smoke cleared, the fighters had disappeared and the six remaining Kuritan ‘Mechs were dispatched by the Davion militia. Out of the six fighters, only one had been damaged. An alert Kuritan Archer pilot fired two salvos at one fighter, and managed to hit its cockpit.

The Davion defenders were informed by their command that the fighters had landed on top of a large plateau nearby. No one could have been more surprised than the Davion commander when two of the five remaining fighters were found abandoned there, cockpits open to the sun. On the seat of the craft were copies of the plans for the CRB-6S, a small silver figurine of a bizarre helmet (the top of which opened, revealing a silver sculpture of a human brain), and a note saying “To the finder: Merry Christmas from Cobalt Enterprises”. It has not been determined who piloted the fighters, or where the pilots went after the attack.

Similar events occurred within five weeks on the Steiner-Marik border and the Liao/Periphery border. All occurred in basically the same way, except that the squadron split up, giving fighters to both sides. The same props were left behind. Each of the Successor States have at least one of these fighters now.

Variants:

As the CRB-6S is a new design (and a limited one at that), there are no existing variants; the New Avalon Institute of Military Science has considered turning one medium laser on each wing around, making a somewhat better space fighter at the cost of some strafing ability.

Notable Fighters and Pilots:

Leftenant Jeffrey Stalin

Stalin is notable not because he is an extraordinary pilot, but because he is one of the few people to pilot the CRB-6S. As a member of the air lance in that great NAIS experiment in force synthesis, the Solar Blade Companies (Jeffrey is in the third), he sees a lot of ground action. Therefore he fights within the atmosphere as much as possible and strafes, given any opportunity. Although Stalin has developed an uncanny peripheral vision, keeping track of every participant in a combat without actually watching them, he relies even more on luck, creativity, and his jet-black Cerberus, the ‘Make My Day’.

CBR-6S Cerberus Aerospace Fighter

Tonnage: 50 tons
 Frame: CE-Kree IV
 Engine: CE 250
 Armament: 1 CE-Nukis Heavy Laser
 CE-Hellbeam Medium Lasers
 Manufacturer: Cobalt Enterprises
 Communications System: CE-8549176320 s
 Targeting / Tracking System: CE-Warlok I

Fuel: 90
 Cockpit: 3
 Heat Sinks: 15
 Armor: 200
 Armor Factor: 12.5
 Cockpit: 6+10
 Nose: 60
 Wings: 33
 Fuselage: 46
 Engine: 32

Simulator Stats:
 Type: CBR-6S Cerberus Tons: 50
 Tonnage: 50 tons
 Thrust: 7
 Overthrust: 11
 Structural Integrity: 7
 Engine 250 12.5

Weapons:
 Type: Location
 Large Laser Nose 5
 Medium Laser Nose 1
 Medium Laser RW 1
 Medium Laser RW 1
 Medium Laser LW 1
 Medium Laser LW 1
 Medium Laser Rear 1

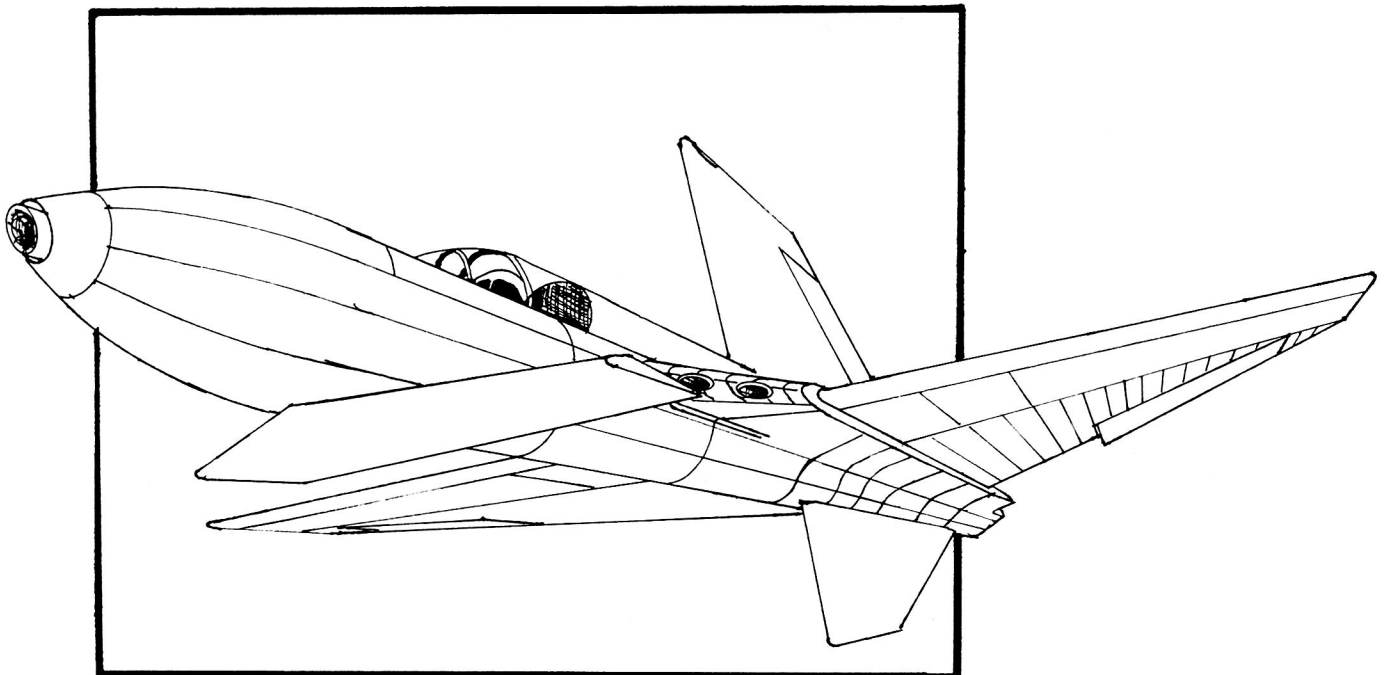

E. Gerdich 89

Readers' Page

Where Were You When The 4th Succession War Began?

Fort Rudyard Kipling; Walham, Morningside

Dear Sirs,

I was standing duty as the Command Duty Officer for the Morningside Joint Planetary Defense Command, thinking about my upcoming wedding, and wondering what in the Queen's name the Elsie's were up to. Most of the brigade knew something was up, due to the high amount of traffic through the House repair depot located nearby; we could not believe it was just "field maneuvers", as we were told.

Then a signals clerk motioned me to a screen on which was playing the infamous royal toast. Upon hearing the worked, "I give you the Capellan Confederation," I went into a near-shock state. In the words of the signaller, I "looked like a ghost in petticoats." Duty overcame fear; as duty officer, I began the steps to full mobilization, both of our brigade and of the planetary militia. I truly wish time could be reversed, so I would not have been author to the blood and fire I released.

Your Obedient Servant,
Victoria Elizabeth Fawnbrook
Colonel, 17th Terran Lancers,
First Terran Light Cavalry Brigade
Morningside, Tamar Pact

Undisclosed Location; Unit censored

Where was I/ Inbound to Quarell on a recon/guerilla action. We had known this was a different type of raid. We had started the run to the planet at high G's and then the announcement was made; we were told of our mission change and of our status as raiders. My response was to pick up more medical supplies and extra ammo for my personal weapons. Then I started to pray, for my brother in the LCAF — and for myself.

Edward W Markle

I was on patrol looking for some of King Oberon's pirates on Bensinger in the Lyran Commonwealth. I'm part of Matzak's Mudrakers, a small merc regiment just hired by the Commonwealth to babysit some water. The Captain of our patrol split our lance into two. My partner Neil Goring in his Centurion and my Shadow Hawk went off on our own.

Unfortunately, we ran into a pirate Dervish and Trebuchet. Neil blew the head off the Trebuchet without taking any serious hits. I did not have such luck. After dueling with the Dervish, my Hawk was in sad shape. Neil had to finish my duel. I was so shot up that the base had to send out a recovery unit for three 'Mechs, including mine. I took two engine hits and a gyro hit. I lost both arms and one leg had locked up. I was barely alive. When I woke up in the infirmary, Neil told me about Davion's pledge to his wife. The war was on. Our orders came in at the same time as the wedding tapes did. We were mobilizing to leave this planet and to go to Gunzberg to act as reinforcements for the mercs of MobileFire and Bad Dreams. The good news is that I got the Dervish, because my Hawk had to be scrapped.

Mechwarrior Chuck Matzak,
son of Commander Robert Matzak

I didn't know it had started until I saw Issue # 0204 of BattleTechnology at my local hobby store, and looked inside. I was

Mech Force Top Fifty

MechWarrior Name	MechForce Ranking
Leutenant-Colonel Michael D Martin	3344
Leutenant-Colonel Edward Markle	2157
Leutenant-Colonel John G Froelich	2070
Leutenant-Colonel Sheila Marie Bellows	2047
Leutenant-Colonel Gunther Harold Bellows	2022
Sho-Sa William C Gushue	1995
Major Michael Blouin	1972
Major Brian L Neldner	1930
Major Westly Patrick	1826
Kommandant Francois Trudelle	1737
Captain John Petrone	1685
Captain Gavin Mc Clements	1645
Captain Ed Savoie	1621
Hauptmann Ronald C Kehir	1605
Leutenant Brian Lee Kendall	1567
Lieutenant Bobby Howell	1547
Chu-i John Gladden	1505
Lieutenant David Heatherley	1503
Sergeant-Major Francois Gousse	1460
Leutenant Larry Pryor	1417
Brevet-Commander Mike Palmer	1398
Sergeant-Major Robert Whidbey	1366
Sergeant-Major Mark Chittenden	1359
Leutenant Robert A Gross Jr	1353
Leutenant Kristopher Miller	1359
Leutenant Hans Jonker	1342
Sergeant Major Mike Wilson	1338
Sergeant Major Michael T Keogh	1333
Sergeant Major David E Parsons	1330
Leutenant Eric Martel	1327
Sergeant Major Don Gilmore	1314
Leutenant Justin Thomas Claypool	1307
Leutenant Scott A Kreiser	1300
Sergeant Major Paul 'Chip' Trace Jr	1296
Sergeant Major Fred Best	1296
Staff Sergeant William A Ransdale	1294
Sergeant Major Daniel Clark	1285
Leutenant Robert Bost	1269
Sergeant Major Rhonda Stocking	1264
Sergeant Major Alex Zehnder	1250
Leutenant Tony Liddle	1245
Staff Sergeant Dora Chittenden	1242
Leutenant James Kehir	1242
Staff Sergeant William Lane Douglas III	1241
Leutenant Don Jenkins	1239
Staff Sergeant Matthew Prince	1212
Leutenant Scott Michael Davenport	1209
Sergeant Major Nils Hagen-Frederiksen	1196
Leutenant Rich Thomas	1194
Sergeant Major Raymond R Dryer	1116

caught by surprise, just as much as ol' "Mad Max" Liao must have been!

Capt David H McCaffrey
CO, Delta Company, Damage Inc

Thank you to everybody who wrote in to share their reminiscences of the beginning of the Fourth Succession War. We can't print any more (we wish we could), but do be sure that each was read and appreciated.

UNLEASH YOUR IMAGINATION...



**DEALER
INQUIRIES
INVITED**



**\$99.95
PER SET
58 PCS.**

Tired of playing your game on the same old board? Move up to the world of 3-D terrain simulation with **BATTLESCAPE™** from GEO-HEX. Based on our award winning and critically acclaimed GEO-HEX™ Terrain Simulation System, **BATTLESCAPE™** is both a flexible terrain display system for miniatures and hex grid gameboard rolled into one.

NO ASSEMBLY IS REQUIRED !!

Covered in your choice of either grass green or desert sand flocking, each **BATTLESCAPE™** set comes completely finished and ready for use. Now you can model streams, rivers, hills, islands, cliffs, etc., from the moment you open the box. And while the unique, patented shapes allow you to create an endless variety of landforms, the overlying 1.5 inch hex size grid allows you to use boardgame rules and movement systems. So leave flat, featureless gameboards behind; ask your local hobby dealer about us or contact us directly at the address below, and enter a realm of adventure with **BATTLESCAPE™**!

**609 NE Schuyler, Unit #1
Portland, OR 97212**

New Address:

**(503) 288-4805
Contact KR**

A COLOR CATALOG OF OUR FULL LINE OF TERRAIN PRODUCTS IS AVAILABLE FOR \$3.00 U.S. VISA AND MASTERCARD HOLDERS CAN CALL, OTHERS SEND CHECK OR MONEY ORDER.

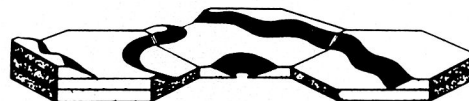

GEO-HEXTM

IF ORDERING FROM THIS AD PLEASE INCLUDE SHIPPING WITH ORDER. US. SHIPPING, 5%; CANADA, 12%; OVERSEAS SURFACE, 15%; AIR 30%. ALL PAYMENTS IN CURRENT U.S. DOLLARS. PRICES SUBJECT TO CHANGE WITHOUT NOTICE.

BATTLETROOPS

A GAME OF URBAN MAN-TO-MAN COMBAT IN THE BATTLETECH UNIVERSE.

'Mechs take the glory. Men take the real estate.'



FASA
CORPORATION

NEW!
A BOXED
GAME FOR
BATTLETECH

'Kick the Can' — slang for ambushing a 'Mech.

BattleTroops is the game of personal combat in the age of the 'Mech. A unique movement and action system can resolve large battles quickly and realistically. The game features all facets of combat in the BattleTech system, including man to man, man to 'Mech, man to vehicle, and the use of normal infantry, jump troops, gun emplacements, and heavy weapons.

Look for BattleTroops where you buy games!

BattleTech, BattleTroops, and 'Mech are trademarks of the FASA Corporation. © 1989 FASA Corporation All rights reserved. FASA Corporation, P.O. Box 6930, Chicago, IL 60680. FASA products are exclusively distributed by TM Games • Chart House • Station Road • East Preston • Littlehamton • West Sussex BN16 3AG • England, and by JEDKO Games • 134 Cochranes Road • Moorabbin, Victoria • Australia 3189